

CoolPoint®

Installation and Operation Manual

Vortex Shedding Flowmeters

Series:

CP/N6- CP/N16



Effective with products having serial number 090100001 and greater

UNIVERSAL FLOW MONITORS, INC.

1755 East Nine Mile Road PO Box 249
Hazel Park, MI 48030-0249
TEL (248) 542-9635 FAX (248) 398-4274

Website: <http://www.flowmeters.com>



TABLE OF CONTENTS

CONTENTS

TABLE OF CONTENTS	2
PROPRIETARY NOTICE	3
USING THIS MANUAL	3
QUICK SET UP.....	4
WIRING DIAGRAMS (Pin Configurations).....	6
INSTALLATION	7
GENERAL SPECIFICATIONS	8
OPERATION	10
APPLICATIONS	10
MODEL CODES.....	10
PRESSURE DROP CHARTS.....	11
CABLING.....	11
DIMENSIONS.....	12
RMA NOTICE RETURN MERCHANDISE AUTHORIZATION.....	13
RMA FORM	15
WARRANTY INFORMATION	16

PROPRIETARY NOTICE

The information contained in this publication is derived in part from proprietary and patented data and has been prepared for the express purpose of assisting in installation, operation, and maintenance of the instruments described herein. Publication of this information does not convey any rights of use or reproduction other than in connection with the installation, operation and maintenance of the equipment described herein. Universal Flow Monitors, Inc. reserves the right to change the information contained in this publication at any time and without prior notice.

USING THIS MANUAL

In order to use this manual, you will need the model code that can be found on the nameplate of the flowmeter, as shown on the example below (see [MODEL CODES](#)). The Model Code allows you to determine minimum and maximum flow capabilities, as well as pressure drop for various sizes.

NAMEPLATE EXAMPLE – CP/N6-CP/N16

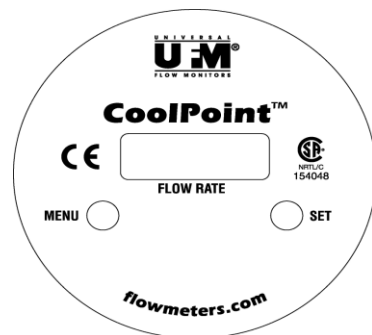
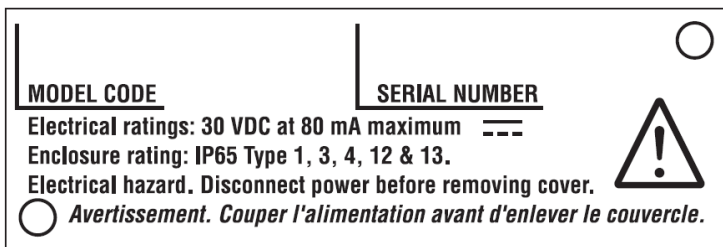

QUICK SET UP

PIPING

Install in pipe making sure to orient IN port to flow supply.

10 pipe diameters distance is required upstream and 5 down for best accuracy.

Use proportional spacing if this much space is not available.

50 pipe diameters are required upstream as distance from a valve.

No use of Teflon tape please. (See detailed piping instructions.)

Attach pin connector/cable assembly to unit. (See detailed wiring instructions.)

CONFIGURATION OF METER

At start up , display shows 888 showing that it's digits are all functional

8.8.8

Next firmware revision is displayed.

4.69

Then model is shown

Cn

Run mode achieved. Flow rate displayed at 0 flow is 0.

0.00

Note that if no adjustments are made, GPM displays, alarm is off and output is 4-20 mA.

SELECTING LPM OR GPM

If flow is started, toggle from LPM to GPM using Set button. LPM will be the higher value.

12.4

OPTING FOR AND SELECTING ALARM POINT

Depress Menu for 1 second.

This will display ALA for alarm mode

ALA

If pulse mode is showing, push Menu button to get back to alarm mode.

PUL

UNIVERSAL FLOW MONITORS, INC.

- Push Set button and default setting of zero will display (indicating that alarm is not active) 00.0
- Depress Menu button repeatedly until desired set point is achieved. 12.6
- Depress Set button to save the setting 12.6
- Settings roll over to zero and start over if you miss it the first time. Only displayed values are feasible.
- Now display shows "nc" indicating that circuit is closed when not in alarm state. nc
- Depress Menu button to change this to "no" indicating that circuit is open when not in alarm state. no
- Depress Set button to save the setting

SELECTING PULSE OUT INSTEAD OF ALARM

- Depress Menu for 1 second.
- This will display ALA for alarm mode ALA
- Push Menu button to change to pulse mode. PUL
- Depress Set button to save the setting
- Note that pulse out is at a predetermined rate of pulses per gallon and is not altered by LPM display.
- 4-20 mA output is not affected by pulse out.

WIRING DIAGRAMS (PIN CONFIGURATIONS)

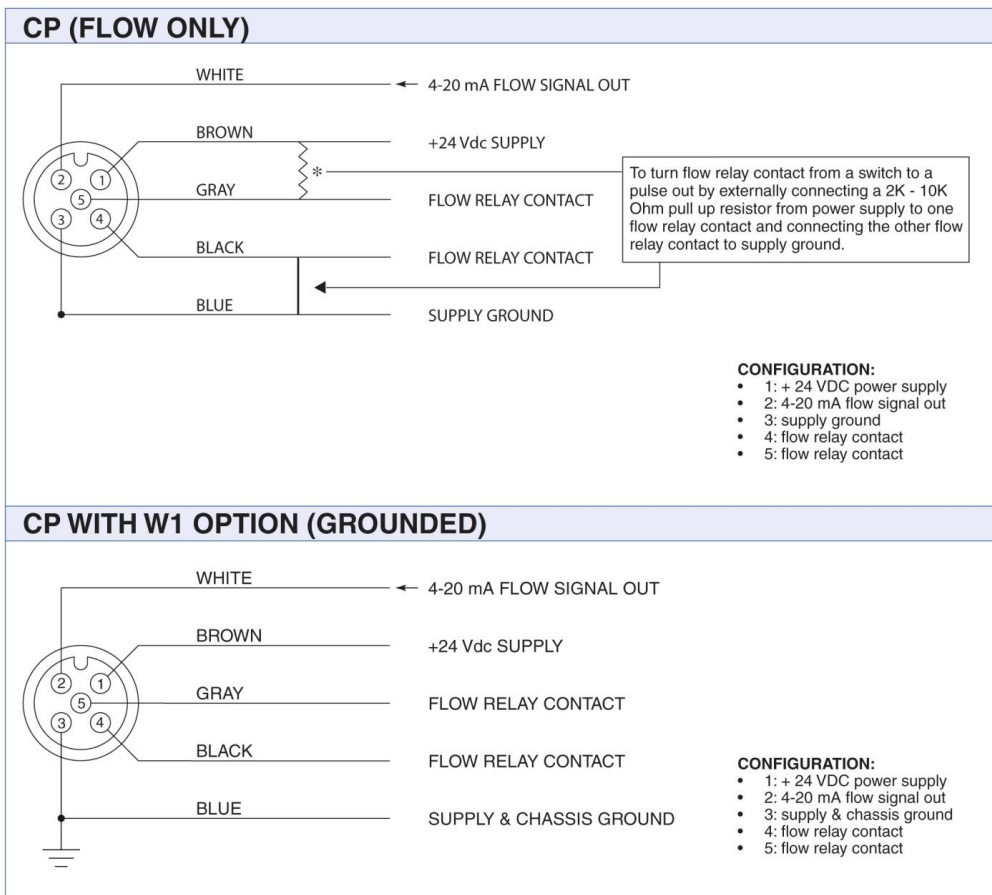

DC Power Supply Voltage Requirements for 4-20 mA Outputs:

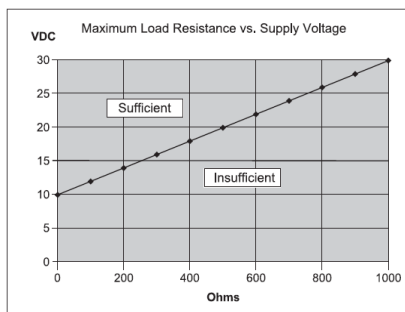

INSTALLATION

For best results, the meters may be installed in any position as long as proper piping installation requirements are observed. This includes sufficient support of adjacent piping to minimize the system's inherent vibration. Unions of the same pipe size and full port isolation ball valves may be installed for ease of removal and servicing of equipment, if necessary. Meters should be placed in horizontal, slightly ascending runs or vertical runs to prevent trapped air from accumulating in the meter. Furthermore, the meters should not be placed at the highest point in the piping. The piping system should be filled slowly to prevent water hammer from damaging the flow sensor. Please note that reverse flow can also damage the flow sensor.

In order to achieve the stated accuracy, a straight pipe run of 10 pipe-diameters (minimum) is required upstream of the meter, as well as 5 pipe-diameters downstream. Isolation ball valves, when used, should be in the full open position. Throttling valves should always be placed downstream of the meter. A minimum straight run of 50 pipe-diameters is required between an upstream valve and the flowmeter.

If Teflon® tape or pipe sealant is used, the user must ensure that no loose parts become wrapped around the bluff or the flow sensor when flow starts.

Use of diaphragm or piston pumps affects the meter's performance unless they are installed with a properly sized pulsation dampener and pressure control. The piping system must create some backpressure on the meter to allow vortex formation and to prevent cavitation, especially at full flow. Minimum required backpressure is 10 PSIG at maximum flow and at 70 °F (21 °C). Higher backpressures are required at elevated temperatures and occasional surges to 125% of maximum flow.

In rare situations, the user may notice an intermittent flow display that drops off while the flow is held steady. In this case, please contact UFM to discuss the backpressure requirements.

GENERAL SPECIFICATIONS

Maximum Operating Pressure:	300 PSIG (20.4 Bar)
Minimum Operating Pressure:	10 PSI of back pressure is required for the formation of vortices. See INSTALLATION and PRESSURE DROP CHARTS
Maximum Operating Temperature:	150 °F (66 °C), 151-210 °F (66-99 °C) with reduced rating of the solid-state relay (This rating applies to both fluid and ambient temperature.)
Minimum Operating Temperature:	35 °F (2 °C) fluid and ambient
Maximum Flow:	Meters may occasionally be over-ranged up to 125% of capacity without damaging the meter. Note: Output is clamped at 21mA (6.3% over-range) but the display will indicate up to 125% F.S.
Flow Capacities:	3/4" = 25 GPM (95 LPM) 1" = 50 GPM (190 LPM) 1 1/2" = 100 GPM (380 LPM) 2" = 200 GPM (750 LPM)
Turndown Ratio (max to min flow):	10:1 standard. 20:1 optional at normal temperatures
Process Connections:	Female NPT with BSPP and BSPT optional
Wetted Parts:	Body is brass or 316 Stainless Steel. Sensor is PVDF or PEEK. Seals are Viton®
Display:	3-digit LED Digit height = 0.3"
Power:	10 - 30 VDC @ 80 mA



Caution: The unit shall be supplied by a SELV (separated extra-low voltage) source in accordance with CSA Standard C22.2 No.1010.1-92 Annex H.

Environmental conditions:	This device has been designed for use in Installation Category I, pollution degree 4, at altitudes up to 2000 meters (6560 ft.), either indoors or outdoors as defined in CSA Standard C22.2 No.1010.1-92.
---------------------------	--

UNIVERSAL FLOW MONITORS, INC.

*Viton® is a registered trademark for DuPont Performance Elastomers.

Electrical Service:	General Purpose
Electrical Classification:	Non-hazardous Type 1, 2, 3, 4 (equal to IP 65), 12, and 13
Power Requirements:	24 VDC (10-30 VDC) @ 80 mA
Cabling:	Male DC micro pin connector standard, pigtails or conduit box optional.
Accuracy:	2% Full scale
Analog Output:	4-20 mA proportional to flow
Response Time:	450 ms.
Repeatability:	.25% of indicated
Solid State Relay:	Standard units have a solid state relay in addition to the transmitted output and it is field selectable to either be a pulse output or a flow alarm.

Alarm Output: Optically-isolated solid-state relay, rated to 125 mA @ 30 VDC, up to 185 °F [50 mA @ 30 VDC between 186-210 °F (85-99 °C)]

Alarm Deadband = 2.5% of full-scale for ¼", 3/8", ½"

Alarm Deadband = 5% of full-scale for all sizes above ½"

Alarm State = NO or NC above setpoint (selectable)

Pulse Output:

The pulse output always indicates flow in GPM. It is driven by the internal solid-state relay. The pulse output can be converted from solid state switching to actual pulse by externally wiring of a 2k to 10k ohm resistor between one of the flow relays and the power supply. Resulting pulse would have 30 VDC maximum pulse amplitude and a pulse width equal to 3 m. See wiring diagrams.

Note: pulse output represents instantaneous flow rate, not an averaged (filtered) value which can result in jitter if no external filter is applied. Pulse rate is 100 pulses/gallon for ¾ -1 ½ inch and 25 pulses/gallon for the 2 inch. This does not change with LPM selection for display.

OPERATION

CoolPoint is an inline flowmeter that utilizes the vortex shedding principle. The fluid strikes a bluff body, generating vortices (eddies) that move downstream. The vortices form alternately, from one side to the other. A piezoelectric sensor housed in a sensor tube directly downstream of the bluff senses the pressure zones created by the vortices. The sensor generates a frequency directly proportional to the vortices (flow). The pulses are then amplified by the circuit board and converted to a 4-20 mA output, which is also linear with flow. Flow is displayed on the LEDs in either GPM or LPM. Selection of the preferred units of measure is made by using the **SET** pushbutton. A solid-state relay can also be set for a low-flow alarm, typically from 15% to 90% of full-scale flow. The relay can be configured to be either NC (normally-closed) or NO (normally-open), or for a pulse output.

APPLICATIONS

CoolPoint can be used on low viscosity, clean or dirty water-like liquids that are compatible with brass, PVDF and Viton. Metered fluids should not include long fibers or a significant level of abrasive solids. Should abrasive wear occur over time, bluffs as well as the sensors are replaceable. Typical applications include cooling loops using water, 50% solutions of glycol, and water-soluble machine coolant (up to 10%). These applications are found in most process industries, including rubber, steel, fabrication, manufacturing, refining, paper, chemical, food, petrochemical and power. They cannot be used on gases (including air), or on flammable liquids.

Note: If used outside the parameters specified in this manual, the proper operation of the flowmeter cannot be guaranteed.

Cleaning: These meters do not require any special cleaning of the external surfaces. If cleaning is deemed necessary, strong solvents, detergents, or chemicals should not be used. A damp cloth may be used to wipe off dirt or debris.

MODEL CODES

UNIVERSAL FLOW MONITORS, INC.

MODEL CODES

Flow maximum GPM (LPM)	Pipe size in inches	Model code	Material	Thread options available	Connector or conduit box options available	Special options
4 (15)	1/4	CP2 **	-M1*=Brass	T1 *=NPT	C1 *=Pin connector	W1 =20:1 extended turndown***
6 (22.7)	3/8	CP3	-M2=316 Stainless Steel	T2 =BSPT	C2 =Pig tails	E20 =High temp (150-210° F)
12 (45)	1/2	CP4		T3 =BSPP	C3 =Conduit box, terminal strip	

* Indicates default selection. If no selection is made, this option is assumed.

Example: CP2 is the same as CP2-M1T1C1

*** Not available on CP2
 *** Needs grounding
 *** Turndown is 20:1 standard temp, 15:1 high temp.

** Use schedule 40 pipe only

PRESSURE DROP CHARTS

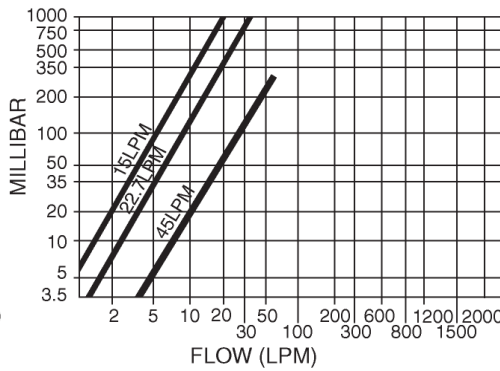
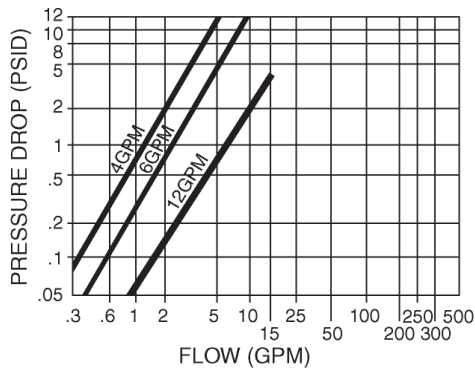

CABLING

ACCESSORY CABLES AVAILABLE FOR PIN CONNECTOR METERS

Series	Description	Length in Meters	Part Number
CP	4 pin female	1	2519-1M
		3	2519-3M
		10	2519-10M
CP	5 pin female	1	6241-1M
		3	6241-3M
		10	6241-10M

DIMENSIONS

INSTALLATION DRAWING – BASIC METERS

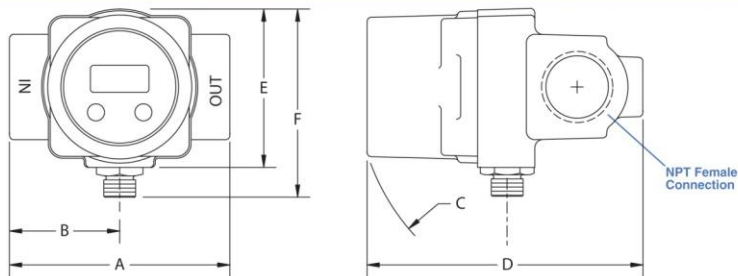

Size	A	B	C	D	E	F
CP2 CP3 and CP4	3.25 [83mm]	1.62 [41mm]	3.25 [83mm]	4.07 [103mm]	2.34 [60mm]	2.77 [70mm]

INSTALLATION DRAWING – METERS WITH OPTIONAL JUNCTION BOX

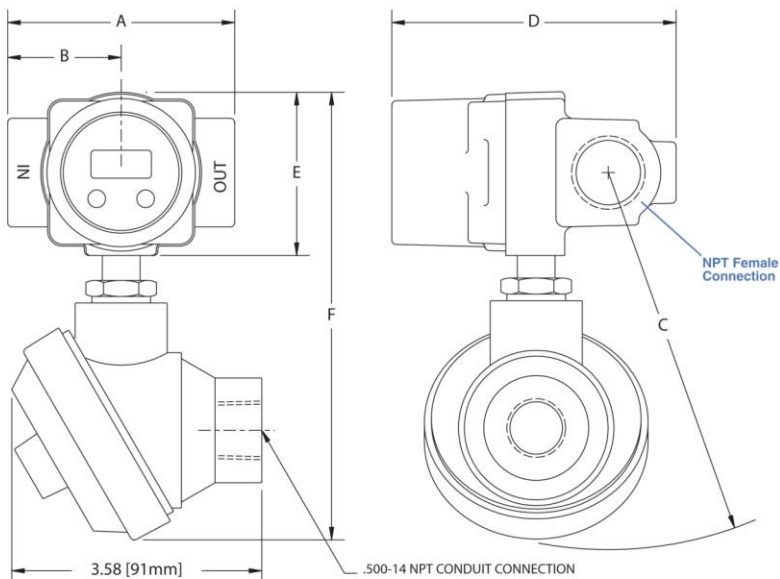

Size	A	B	C	D	E	F
CP2 CP3 and CP4	3.25 [83mm]	1.62 [41mm]	5.4 [137mm]	4.07 [103mm]	2.34 [60mm]	6.41 [163mm]

RMA NOTICE RETURN MERCHANDISE AUTHORIZATION

Please read the following UFM policy information carefully. By following the guidelines outlined below you will assist in providing a timely evaluation and response regarding the status of your flow meter. UFM evaluates all AUTHORIZED RETURNED MATERIALS in a timely manner and will promptly provide notification regarding the status of the related materials and/or a written quotation indicating the total charges and description of the necessary repairs.

- 1 All returns must have a RMA form completed by the customer.
- 2 Any meter returned that was previously in service must have the OSHA requirements completed and a MSDS included where applicable.
- 3 An RMA number will only be issued when UFM has received a copy of the completed RMA form and any applicable MSDS.
- 4 A "Return Goods" shipping label (located in the back of the Instruction Manual) must be used for returning materials to UFM.
- 5 Returned goods must be shipped prepaid or they will be rejected.

REPAIRABLE MATERIAL

Written or verbal authorization to proceed with the repair under an assigned Purchase Order, must be received within 30 days of repair quotation. If the unit(s) are repaired, the \$90.00 evaluation charge will be applied to the quoted repair costs. If no repairs are authorized within this 30 day period, the customer will be billed \$90.00 plus shipping charges and the materials will be returned to the customer.

NON-REPAIRABLE MATERIAL

If materials are found not repairable, a written notice that the material is not repairable will be provided to the customer by UFM. If no disposition to scrap or return the material is received from the customer within 30 days, un-repairable material will be scrapped and the customer will be billed the \$90.00 evaluation charge. If a UFM replacement unit is purchased within 30 days of non-repairable condition notice, the \$90.00 evaluation fee will be waived. The return of non-repairable materials may be ordered by customer Purchase Order providing for shipping and handling charges.

RETURN FOR RESTOCK All goods returned for restock adjustment **must** be:

A. New and unused.

B. Returned to the factory within ONE YEAR of date of original shipment.

C. Returned through the distributor where the goods were originally purchased. This material will also be subject to an evaluation charge of \$90.00.

UNIVERSAL FLOW MONITORS, INC.

The customer will be advised of the restocking adjustment for all restockable goods. Upon acceptance of the restocking adjustment, by the customer, the \$90.00 evaluation fee will be waived and a credit issued by UFM. The customer will be advised of any **non-restockable** goods and will be charged the \$90.00 evaluation fee plus any shipping charges if returned to the customer.

If no disposition is received by UFM within 30 days, the goods will be scrapped and the \$90.00 evaluation fee will be billed.

WARRANTY RETURNS

Warranty returns must be shipped prepaid to UFM. UFM will review the goods and advise the customer of the evaluation and validity of the warranty claim. Valid warranty claims will be repaired or replaced at no charge. No evaluation fee will be charged for repairs made under warranty. Return shipping costs will be prepaid by UFM. Should UFM determine the returned material is not defective under the provisions of UFM's standard warranty, the customer will be advised of needed repairs and associated costs. All materials returned for warranty repair that are determined to not have a valid warranty claim will be subject to the "**Repairable Material**" policy outlined above.

RMA FORM

UNIVERSAL  FLOW MONITORS	RETURN MATERIAL AUTHORIZATION E-MAIL: ufm@flowmeters.com 1755 E. Nine Mile Rd., Hazel Park MI 48030 PH: (248) 542-9635 Fax: (248) 398-4274
---	---

IMPORTANT: This form must be filled out completely and faxed to the Repair Department prior to issuing a RMA # (UFM) / NRA # (ROCON)

Customer: _____	Product Information	Qty: _____
_____	Model Code: _____	_____
_____	S/N: _____	_____
_____	Sales Order: _____	_____
Contact Name: _____	_____	
Phone # _____	_____	
FAX # _____	Are before (as found) and after readings required?	
E-mail: _____	_____ Yes _____ No	
Reason for return: (Please be detailed as possible. Lack of Information may increase labor charges.)		
Mechanical		Electronics
<input type="checkbox"/> Leaks	<input type="checkbox"/> No signal	
<input type="checkbox"/> Sticks	<input type="checkbox"/> Inaccurate signal	
<input type="checkbox"/> Calibration Off	<input type="checkbox"/> No Display	
<input type="checkbox"/> Switch does not work	<input type="checkbox"/> Other (describe below)	
<input type="checkbox"/> Other (describe below)		
Details: _____		

<p>Note: There will be a minimum evaluation charge of \$90.00 for all units returned (excluding units covered under warranty). Units WILL NOT be accepted without a valid Return Material Authorization Number (RMA#). A Material Safety Data Sheet on the process fluid must be received, when applicable, prior to the RMA# being issued.</p>		
* OSHA Requirements: (to be filled out by customer) NO EXCEPTIONS!!		
Process Fluid: _____		
Meter must be flushed to remove all process fluids.		
I hereby certify that the material being returned has been properly flushed and cleaned of all hazardous materials and does not require any special handling.		
Print or Type Name _____	Signature: _____	
Title _____	Date: _____	

Distributor Information	INTERNAL USE ONLY	# _____ Authorized by _____ Date _____
Company Name _____		
Contact Name _____		
PO # _____		
Phone # _____ FAX # _____		

WARRANTY INFORMATION

1) ACCEPTANCE AND INTEGRATION CLAUSE: This Sales Order Acknowledgment and the sales order information that Universal Flow Monitors, Inc. ("Universal") attaches to or associates with it (herein "Acknowledgment"), constitutes an acceptance by Universal of an offer by the buyer upon the conditions and terms and at the prices stated in this Acknowledgment. The Acknowledgment contains the entire understanding of Universal and the buyer regarding the subject matter of said Acknowledgment. This Acknowledgment may only be modified by a written agreement signed by the party against whom enforcement is sought.

2) WAIVER: Waiver by Universal of any default(s) by the buyer shall not constitute waiver by Universal of any of the conditions of the agreement between Universal and the buyer as set forth hereunder with respect to any further or subsequent default by the buyer.

3) FORCE MAJEURE: Universal shall not be responsible for failure or delays in deliveries due to fire, strikes, breakdowns, acts of God, failure of carriers, inability to secure required materials, or other causes beyond Universal's control. Buyer waives any claims for damage arising by virtue of delay in delivery of material by Universal.

4) LIMITED WARRANTY:

(a) Warranty. For a period of one year from the date of manufacture, Universal warrants that each product covered by this Acknowledgment will be free from defects in material and workmanship. In order to qualify for any remedy provided in this Acknowledgment, buyer must give notice to Universal within the one-year period, return the product to Universal freight paid and intact with Material Safety Data Sheets covering all substances passing through the product or that form a residue on the product.

(b) Exclusive Remedy. The buyer's EXCLUSIVE REMEDY for failure of any product to conform to any warranty or otherwise for any defect is, at Universal's sole option: (i) repair; (ii) replacement; or (iii) refund of the entire purchase price for the specific product. Without limiting the foregoing, in no case will Universal be liable for de-installation of any defective product or installation of any repaired or replaced product. THIS REMEDY IS THE EXCLUSIVE REMEDY AVAILABLE TO THE BUYER OR ANY OTHER PERSON. UNIVERSAL SHALL NOT BE LIABLE FOR ANY DIRECT, INDIRECT, INCIDENTAL, CONSEQUENTIAL, SPECIAL, PUNITIVE, OR OTHER DAMAGES IN CONNECTION WITH ANY CAUSE OF ACTION, WHETHER IN CONTRACT, TORT, OR OTHERWISE.

(c) Disclaimer of Other Warranties. The express warranty in this Acknowledgment is in lieu of any other warranty, express or implied. Without limiting the foregoing, UNIVERSAL DISCLAIMS THE IMPLIED WARRANTY OF MERCHANTABILITY AND ANY IMPLIED WARRANTY OF FITNESS FOR A PARTICULAR PURPOSE.

(d) Special Note About Fitness for a Particular Purpose. This website and other materials of Universal may place products into, or display products in, categories according to function, size, construction, materials, or other property. This is for organizational purposes only and NO PLACEMENT OF ANY PRODUCT IN ANY CATEGORY OR ANY PRESENTATION OF A PRODUCT IN RELATION TO OTHER PRODUCTS WILL CONSTITUTE A WARRANTY OF FITNESS FOR A PARTICULAR PURPOSE.**5)**

PROHIBITED USES: As a condition of the sale of goods or services, buyer will not use, sell, distribute, or otherwise transfer for use, or permit to be used, sold, distributed, or otherwise transferred any product purchased from Universal for any of the following uses:

(a) Nuclear Energy Applications. Any application involving, directly or indirectly: (i) exposure of any product to any hazardous properties of nuclear material; (ii) dependence on the proper functioning of the product for the operation of a nuclear facility by any person or organization; (iii) use in or for any equipment or device used for the processing, fabricating or alloying of special nuclear material if, at any time, the total amount of such material on the premises where such equipment or device is located consists of or contains more than 25 grams of (A) Plutonium (any isotope) or Uranium 233 or any combination thereof; (B) more than 250 grams of Uranium 235; (iv) use in, or for the control of any aspect of, any structure, basin, excavation, premises or place prepared or used for the storage or disposal of waste. The foregoing include, without limitation, any application involving nuclear material contained in spent fuel or waste that is possessed, handled, used, processed, stored, transported or disposed of, any application related to the furnishing of services, materials, parts or equipment in connection with the planning, construction, maintenance, operation or use of any nuclear facility.

(b) Aircraft Applications. Any application involving direct or indirect installation in or on, or use in connection with, any aircraft or aircraft product.

(c) Definitions. As used in this section, the following definitions apply, whether the terms use initial capitals or not.

"Aircraft" includes powered and non-powered winged aircraft, missiles, spacecraft, and other aeronautical craft or mechanisms.

"Aircraft product" includes:

- (1) Any ground support or control equipment used with any aircraft;
- (2) Any article designed for installation in or on aircraft;
- (3) Any ground handling tools or equipment used with aircraft;
- (4) Any aircraft training aids, instructions, manuals, or blueprints; and
- (5) Any engineering, labor or other services involving aircraft.

"Hazardous properties" include radioactive, toxic or explosive properties;

"Nuclear facility" means

- (a) Any nuclear reactor; or
- (b) Any equipment or device designed or used for:
 - (1) Separating the isotopes of uranium or plutonium;
 - (2) Processing or utilizing spent fuel; or
 - (3) Handling, processing or packaging waste.

"Nuclear material" means source material, special material or by- product material;

"Nuclear reactor" means any apparatus designed or used to sustain nuclear fission in a self-supporting chain reaction or to contain a critical mass of fissionable material.

"Property damage" includes all forms of radioactive contamination of property.

"Source material," "special nuclear material," and **"by-product material"** have the meanings given them in the Atomic Energy Act of 1954 and any regulation promulgated thereunder, as the same may be amended from time to time.

"Spent Fuel" means any fuel element or fuel component, solid or liquid that has been used or exposed to radiation in a nuclear reactor.

"Waste" means any waste material

- (1) containing by-product material and
- (2) resulting from the operation by any person or organization of any nuclear facility.