

DELTA POINT TM

DC Version Installation and Operation Manual 12 GPM



ROCON LLC
1755 East Nine Mile Road
PO Box 249
Hazel Park, MI 48030-0249
TEL (248) 542-9635 FAX (248) 398-4274
Website: <http://www.RoconLLC.com>

TABLE OF CONTENTS

TABLE OF CONTENTS 2

PROPRIETARY NOTICE 3

USING THIS MANUAL 4

 Nameplate Example..... 4

SPECIFICATIONS – 12 GPM (45 LPM) UNIT 5

 Pressure Drop Data 5

HOW VORTEX SHEDDING FLOW METER WORKS 6

UNIT FRONT VIEW..... 7

FRONT VIEW, ELECTRICAL ENCLOSURE, COVER REMOVED 8

UNIT REAR VIEW 9

UNIT SIDE VIEW..... 10

HOW THE DELTAPOINT MONITORS COOLING WATER IN THE ROBOTICS CELL..... 11

INSTALLATION 12

SUGGESTED START UP PROCEDURE 13

 START-UP TEST CYCLE..... 14

INDICATOR LIGHTS, PROGRAMMING KEYPAD, AND LCD MESSAGES EXPLAINED 15

INDICATOR LIGHTS, PROGRAMMING KEYPAD, AND LCD 16

MESSAGES EXPLAINED - CONTINUED 16

 Programming via Keypad..... 16

INDICATOR LIGHTS, PROGRAMMING KEYPAD, AND LCD 17

MESSAGES EXPLAINED - CONTINUED 17

INDICATOR LIGHTS, PROGRAMMING KEYPAD, AND LCD 18

MESSAGES EXPLAINED - CONTINUED 18

INDICATOR LIGHTS, PROGRAMMING KEYPAD, AND LCD 19

MESSAGES EXPLAINED - CONTINUED 19

 Viewing Flow Comparison Values 19

 Viewing Firmware Revision..... 19

 Factory Reset..... 19

PROGRAMMING - USER MENU..... 20

 STANDARD FACTORY SETPOINTS 20

 Set Min Flow 20

PROGRAMMING - USER MENU CONTINUED 21

 Set Flow OK..... 21

 Set Leak Rate 21

PROGRAMMING - USER MENU CONTINUED 22

 Set Over / Under Temperature 22

PROGRAMMING - USER MENU CONTINUED 23

 Set Response Time 23

 Restart Delay 23

PROGRAMMING - USER MENU CONTINUED 24

ELECTRICAL CONNECTORS..... 25

MAINTENANCE 26

 Shut-Off Valve..... 26

 Check Valve 26

 Cleaning..... 26

 Note..... 26

TROUBLESHOOTING 27

DIMENSIONS..... 31

MODEL CODES 33

APPENDIX..... 34

 Check Valve Specifications..... 37

 Shut-Off Valve Specifications 37

RMA NOTICE RETURN MATERIAL AUTHORIZATION 38

RMA FORM 39

ROCON / DELTAPOINT WARRANTY 40

PROPRIETARY NOTICE

The information contained in this publication is derived in part from proprietary and patented data. This information has been prepared for the express purpose of assisting in installation, operation, and maintenance of the instruments described herein. Publication of this information does not convey any rights of use or reproduction other than in connection with the installation, operation and maintenance of the equipment described herein. Universal Flow Monitors, Inc. and Rocon LLC reserve the right to change the information contained in this publication at any time and without prior notice.

USING THIS MANUAL

In order to use this manual, you will need the model code that can be found on the nameplate of the flow meter, as shown on the example below (see [MODEL CODES](#)). The Model Code allows you to determine minimum and maximum flow capabilities for the Delta Point water saver.

Nameplate Example

○	MODEL CODE:	DPL - B - 6 0126N	○
	S/N:	DP0 000 000	SO#: 100 000

SPECIFICATIONS – 12 GPM (45 LPM) UNIT

Supply Power: 20-24 VDC @ 700 mA (valve on)
 Network Power: 11-24 VDC @ 90 mA
 Minimum Water Flow: 0.8 GPM (3 LPM)
 Maximum Water Flow: 12.0 GPM (45 LPM)
 Flow Measurement Accuracy: ±0.24 GPM (±0.9 LPM)
 Flow Measurement Repeatability: 0.25% of actual flow
 Minimum Detectable Leak: 0.5 GPM (1.9 LPM)
 Response Time (Cap Pulled to Fault): 1.0 sec. typical with 30 feet. ¾ hose (9 meters)
 Restart Delay: 1.0 – 3.0 sec. (user selectable) (See Note 1)
 Water Temperature Range: 40 °F (4.4 °C) - 180 °F (82 °C)
 Temperature Probe Accuracy: ±2 °F (±1 °C) from 32–200 °F (0–93 °C)
 Operating Temperature Range: 32 °F (0 °C) - 122 °F (50 °C)
 Storage Temperature: -4 °F (-20 °C) - 158 °F (70 °C)
 Port Size: ¾" NPTF (¾" BSPP)
 Supply Water Pressure
 Minimum: 15 PSIG (1.0 bar)
 Maximum: 100 PSIG (7 bar)
 Differential Water Pressure
 Minimum: 5 PSID (.34 bar)
 Maximum: 90 PSID (6 bar)
 Pressure Drop Across Manifold
 (Including shut-off valve, manifold,
 ¾" I.D. 8-ft. hose, check valve): 2.1 PSIG @ 6 GPM @ 70 °F (.14 bar @ 22.7 LPM @ 21 °C)
 Wetted Parts (Body and Sensor): Brass, PVDF
 Electrical Enclosure: Aluminum
 Weight: 14 lb. (6.4 kg.)

Pressure Drop Data

GPM	1.5	2.0	3.0	4.0	5.0	6.0	7.0	8.0	9.0	10.0	11.0	12.0	13.0	14.0	15.0
PSID	0	.5	1	1.2	1.6	2.1	3.2	4.2	6	8.1	10.2	12.7	15.1	17.9	20.9

*Measured from inlet shut-off valve, through the unit, ¾" I.D. 8 ft. hose loop, back through the unit and check valve.



Caution: The unit shall be supplied by a SELV (separated extra-low voltage) source in accordance with CSA Standard C22.2 No.1010.1-92 Annex H.

Environmental conditions: This device has been designed for use in Installation Category I, pollution degree 4, at altitudes up to 2000 meters (6560 ft.), either indoors or outdoors as defined in CSA Standard C22.2 No.1010.1-92.

Note 1: There is an additional 3-second delay at power-up associated with displaying the firmware banner. This delay is bypassed if a remote restart is sent to the instrument.

HOW VORTEX SHEDDING FLOW METER WORKS

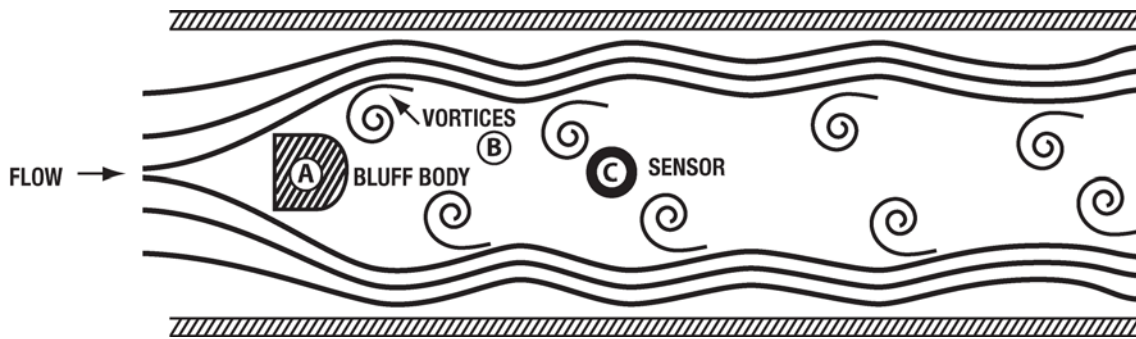

When fluid passes by a bluff, oscillations occur. Examples of these oscillations in nature include the swirls produced downstream of a rock in a rapidly flowing river, or the waving of a flag in the wind with the bluff being the flag pole.

DeltaPoint Unit Supply Water Leg example above: The fluid strikes a bluff body (A), generating vortices (B) (eddies) that move downstream. The vortices form alternately, from one side to the other. A piezoelectric sensor housed in a sensor tube (C) directly downstream of the bluff senses the pressure zones created by the vortices. The sensor generates a frequency directly proportional to the vortices (flow). The pulses are then measured by the microprocessor.

Each DeltaPoint Unit has two vortex shedding flow meters. One flow meter monitors the supply path, and the other flow meter monitors the return path along with the temperature probe*.

PLEASE NOTE: Bluff / Sensors not effected by dirty water.

*Exception HMIN – Temperature probe installed in Supply Temperature well.

UNIT FRONT VIEW

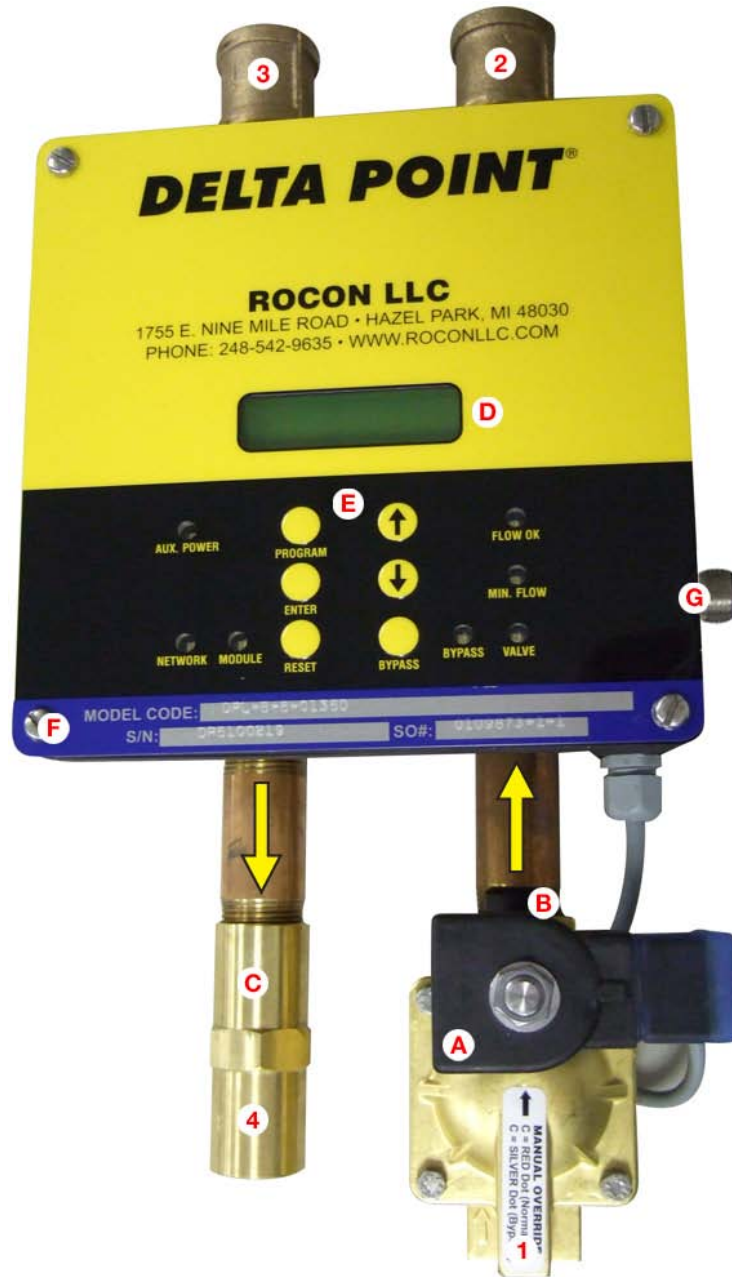

- A = Solenoid NC 2way Shutoff Valve
- B = Manual Bypass Knob
- C = Check Valve
- D = Cover - LCD Screen
- E = Cover - LED / Program Buttons
- F = ID Tag
- G = DC 6 Pin Electrical Connector

- 1 = Supply
- 2 = To Cell
- 3 = From Cell
- 4 = Return

FRONT VIEW, ELECTRICAL ENCLOSURE, COVER REMOVED

A = Key Pad
B = LCD Screen

Electrical Box with Key Pad
and LCD Screen Removed
C = Supply Sensor
D = Mother Board
E = Return Sensor
F = Temperature Probe

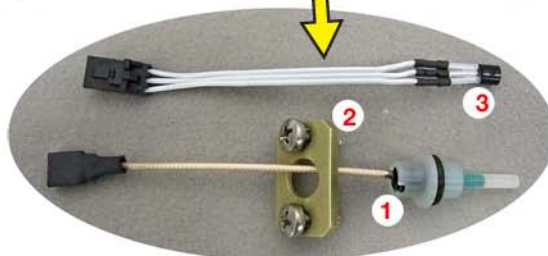
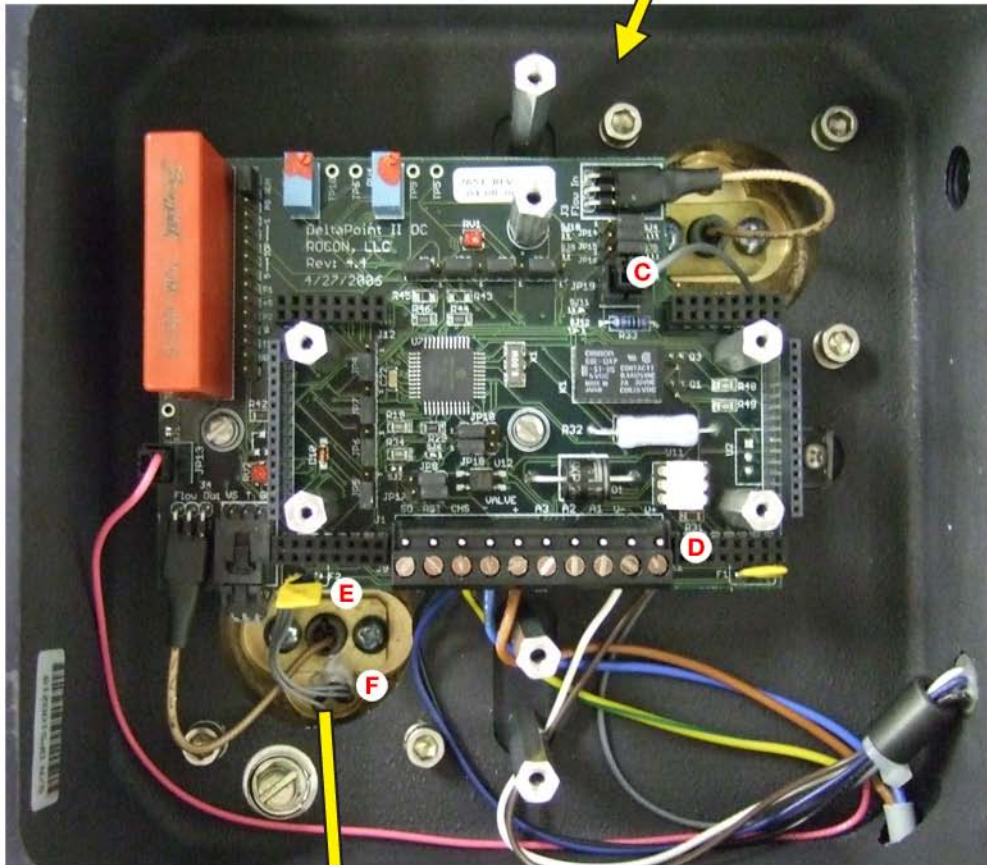
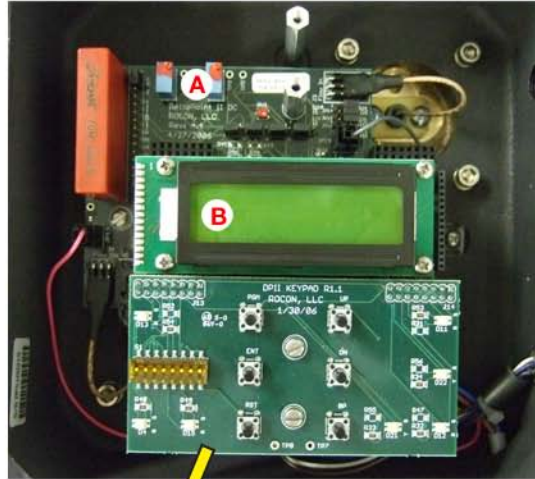

1 = Sensor (W/ ORing)
2 = Sensor Hold Down Bracket
3 = Temperature Probe

UNIT REAR VIEW

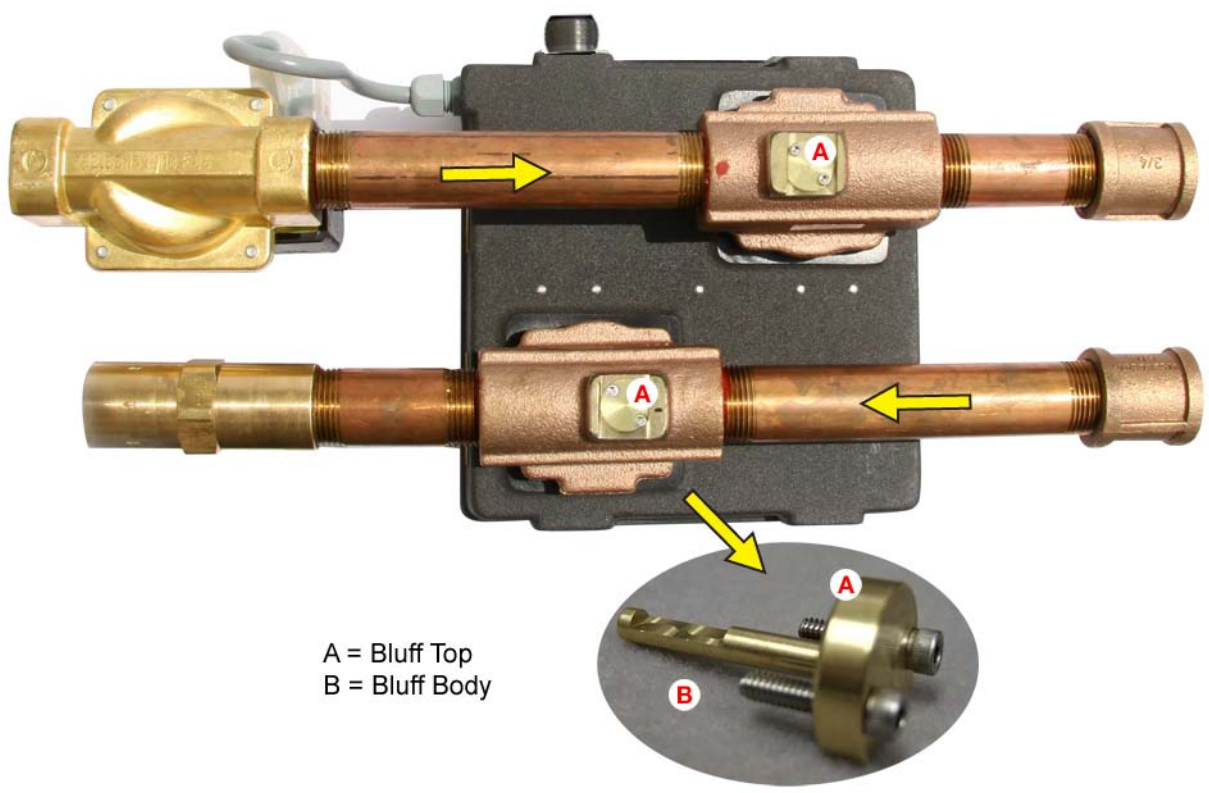

A = Bluff Top
B = Bluff Body

UNIT SIDE VIEW

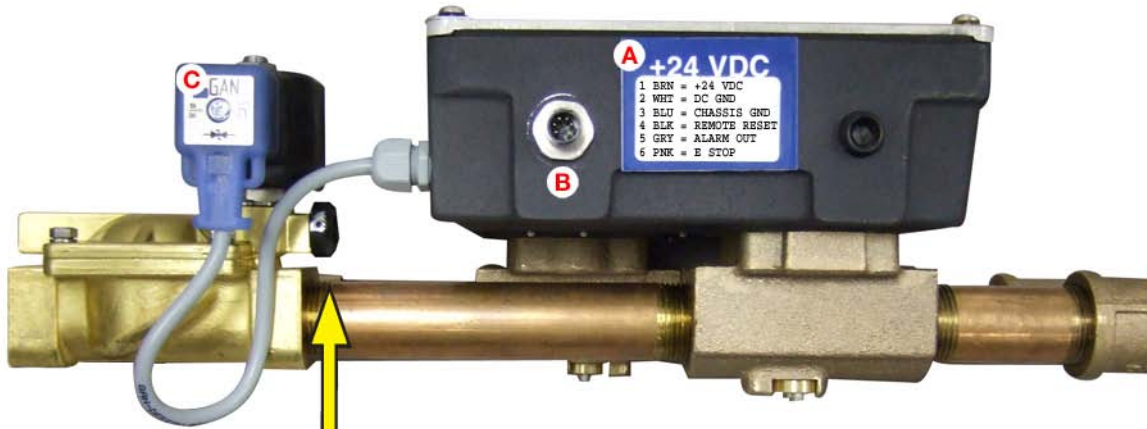

A +24 VDC
1 BRN = +24 VDC
2 WHT = DC GND
3 RED = CHASSIS GND
4 BLK = REMOTE RESET
5 GRY = ALARM OUT
6 PNK = E STOP

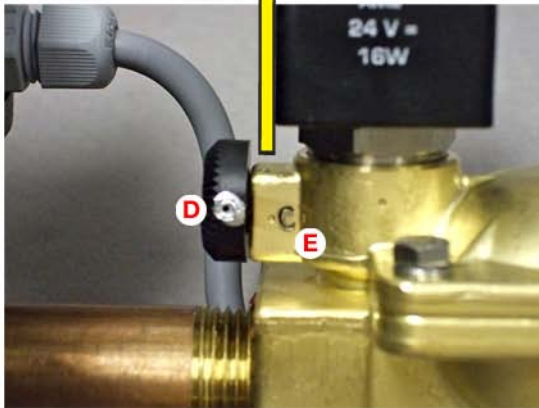

- A = Electrical Tag
- B = DC Electrical Connector
- C = Shut Off Valve DIN Connector LED
- D = Manual Override Knob (360°)
- E = Stamped "C"

REFERENCE
MANUAL OVERRIDE
C = RED Dot (Normal)
C = SILVER Dot (Bypass)

HOW THE DELTAPOINT MONITORS COOLING WATER IN THE ROBOTICS CELL

Each DeltaPoint unit has two vortex shedding flow meters. One flow meter monitors the supply path, and the other flow meter monitors the return leg. The fluid strikes a bluff body, generating vortices (eddies) that move downstream. The vortices form alternately, from one side to the other. A piezoelectric sensor housed in a sensor tube directly downstream of the bluff senses the pressure zones created by the vortices. The sensor generates a frequency directly proportional to the vortices (flow). The pulses are then measured by the microprocessor.

An internal temperature sensor, housed in a small thermo well downstream of the return flow sensor, measures the fluid temperature coming from the cell. This verifies the return water temperature.

The robotic cooling water enters through the SUPPLY port and travels through the inlet flow sensor, continues through the TO CELL port and to the equipment to be cooled. Water that has cooled the equipment reenters the unit through the FROM CELL port, through the return flow sensor and is then discharged into the plant return water system.

The inlet and outlet flow meter signals are compared. When a cap is pulled or a hose bursts the flow in the return leg drops below the supply leg. The microprocessor detects this difference and signals the weld controller to stop welding. It also shuts off the cooling water via a solenoid valve in the supply leg and a check valve in the return leg, thus stopping the water flow in both directions.

No field adjustment required, each unit is calibrated and tested at the factory. In fact no adjustments or tweaking needed even out of the box. Just connect the power and the unit is ready for operation. If custom adjustments preferred the unit is very easy to program for the following: FLOW OK, MINIMUM FLOW, HIGH and LOW TEMPERATURE, LEAK RATE, RESPONSE TIME or RESTART DELAY and finally USA or METRIC setting.

INSTALLATION

- 1 DeltaPoint unit is preferred to be mounted on the outside of the fence line, for ease of service.
 - 2 DeltaPoint can be mounted in any orientation: horizontally, vertically or at any other angle. The orientation has no effect on performance. It is suggested that unions or hosing be used when connecting to the main supply and return piping, this will facilitate ease of maintenance or removal of unit if needed.
 - 3 The Cover can be rotated 180° to change the location of the shut off devices. Contact factory.
 - 4 Caution: Brass pipe nipples installed on the "Supply" and "From Cell" ports cannot be removed. They are needed for proper operation of the flow sensors
 - 5 See [DIMENSIONS](#) for mounting hole pattern.
 - 6 Connecting fluid ports: The unit has ¾-inch NPT female pipe ports. Port 1 "SUPPLY" cooling water into the unit, Port 2 "TO CELL" cooling water to tooling or robot, Port 3 "FROM CELL" returns water from the cell or robot. Port 4 "RETURN" cooling water leaving the DeltaPoint unit.
 - 7 Units can be installed where the pipe or hose diameter is larger than the port size. Do not exceed ¾-pipe or hose diameter with the 4 GPM unit and 1-inch pipe or hose diameter with the 12 GPM unit.
Caution: Water flow cannot exceed 5 GPM for a 4 GPM unit and 15 GPM for a 12 GPM unit.
 - 8 Connecting electrical power. All units have an Electrical Callout Tag reference page 20 that describes the pin number, location, wire color and function.
 - 9 **CAUTION:** PLEASE REFER TO PAGE 34 AT START UP WHEN THE PLANT FIRST INTRODUCES WATER INTO THE COOLING WATER SYSTEM MAKE SURE ALL THE SUPPLY WATER BALL VALVES TO EACH ROCON UNIT ARE CLOSED. WHEN THE COOLING WATER SYSTEM HAS STABELIZED START TO OPEN THE BALL VALVES SOLWLY. THIS WILL PREVENT A WATER HAMMER THAT COULD EFFECT THE LIFE OF THE SENSORS (Could have warranty issues). TURNING THE MAIN WATER PUMPS ON AND OFF FOR THE WEEK END IS NOT RECOMMENDED PRATICE UNLESS YOU CLOSE ALL THE BALL VALVES FIRST TO PREVENT WATER HAMMER DURING MONDAY AM START UP.
 - 10 Installation is complete.
- If problems contact the factory. 248-542-9635 or 24 hour service contact 1-877-684-0589

SUGGESTED START UP PROCEDURE

1. Water OFF/Power OFF.
2. Connect electrical cable to Switch Box, turn Power ON. The LCD Screen and Power Light will be activated. If a problem occurs, see [TROUBLESHOOTING](#).

A – Power activated – LCD Screen

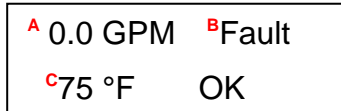

A = 0.0 GPM, Water flow not present.
B = FAULT, No water flow, ALARM
C = Water Temperature

B – Power activated – Status Lights



“FLOW OK” Green LED off

“MIN FLOW” Yellow LED – Solid

“VALVE”, Red LED – Solid

3. WATER ON – **SLOWLY** turn the water shut-off ball valves open in both Supply and Return water legs.
Push the **RESET** Button located on the front cover to allow circulation to remove air; clear all faults and restart the unit.

A – LCD Screen

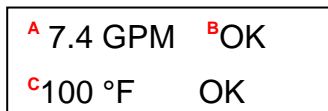

A = Actual Supply Water Flow
B = Water Flow Status OK
C = Water Temperature

B – Status Lights



“FLOW OK”, Green LED – Solid

“MIN FLOW” Yellow LED - off

Shut-off valve DIN connector light is ON to indicated valve is open; otherwise, there will be no flow.

START-UP TEST CYCLE

Shut-Off Fault Alarm and Weld Controller Fault Alarm Test

If unit is operational with water flow present:

1. Turn one of the cooling water shutoff valves OFF.
2. The LCD screen indicates "Water Flow Fault."
3. The LED status lights indicate that:
 - a) Minimum/Low Flow – Solid (Yellow)
 - b) Shut-Off Closed – Solid (Red)
4. The DIN Connector LED on Solenoid Valve is OFF, because the shut-off valve solenoid coil is deactivated.
5. Confirm that the Weld Controller received "Water Flow Fault".
6. Open the cooling water ball valve; push **RESTART**. Unit should be activated as described above.
7. If no problems occurred, proceed to the next test. If unit did not pass, see [TROUBLESHOOTING](#).

Leak and Response Time Test

If unit is operational with water flow present:

1. Pull off one of the weld gun arm electrode caps.
2. The water shuts off and the LCD screen indicates "Fault." Status Lights #1 and #3 are activated.
3. Reinstall weld gun cap.
4. Send a **remote RESTART** or push **RESTART** on the front panel of the unit and wait 3 seconds for the unit to return to normal operation.
5. Pull off the other weld gun arm cap. And verify Steps 1-4, above.
6. If a faster response time is needed, lower the response time and/or the leak rate (see [USER MENU](#)).

CAUTION:

- If the setting gets too low or is too fast, false leak faults could occur. Continue testing until satisfactory results are obtained.
7. If the unit passed the above tests, it is ready for the production line.



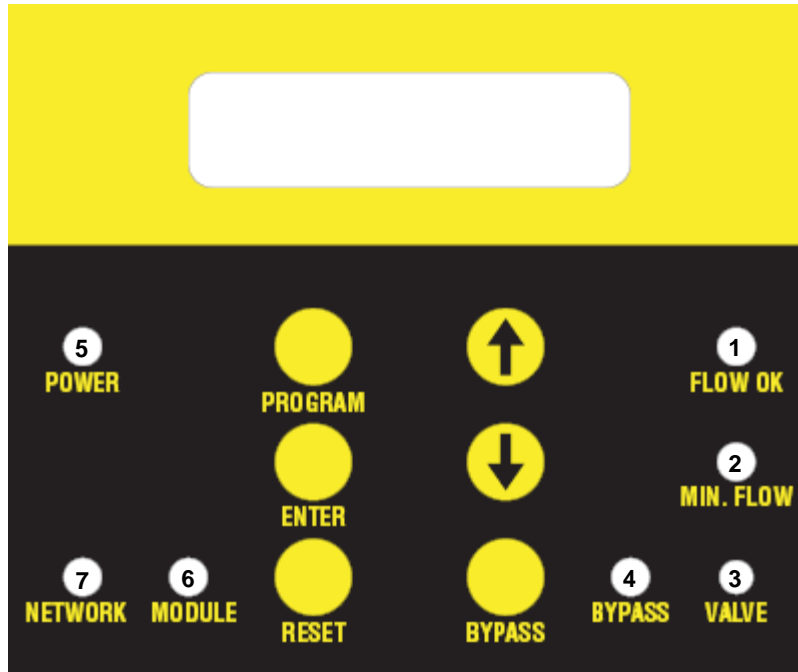





INDICATOR LIGHTS, PROGRAMMING KEYPAD, AND LCD MESSAGES EXPLAINED



	Color	Status	Function	Comments
1	Green	Solid	OK	Programmable. Flow => Flow OK set point. LCD shows "Flow OK"
1	Green	Flashing	Temperature Fault	Programmable. Temperature exceeds Temp. Fault set points. High or Low LCD shows "Fault" on the second line.
2	Yellow	Solid	Low Flow	Non-programmable. Flow is between Min Flow and Flow OK set points. LCD shows "Low Flow"
2	Yellow	Solid	Minimal Flow	Programmable. Flow =< Min Flow set point. LCD shows "Min Flow" (Note: Text on the instrument cover plate may show Flashing = Minimal Flow. This is no longer the case. The firmware has been revised to keep the yellow LED solid under both Low and Minimal flow conditions.)
3	Red	Solid	Valve Shut	Shut-off valve closed. Can happen when leak exceeds Leak Rate set point or flow < Low Flow.
3	Red	Flashing	Valve Shut Off Failure	Shut-off valve failure. Power off to coil but water flow is still present.
4	Yellow	Solid	In Bypass	"BYPASS" button pushed, shut-off valve <i>forced</i> open.
4	Yellow	Flashing	Flow Fault in Bypass	Flow fault detected but valve cannot be shut off because the unit is in "Bypass."
5	Green	Solid	Power On	24V-DC present.
6	Green / Red	Solid	Network Communication	Network Communication for Devicenet, Ethernet or Profinet
7	Green / Red	Solid or Flashing	- Network Communication	Network Communication for Devicenet, Ethernet or Profinet

INDICATOR LIGHTS, PROGRAMMING KEYPAD, AND LCD MESSAGES EXPLAINED - CONTINUED

Programming via Keypad

- 1  Push and hold for 1 second to enter User Menu.
- 2  User Menu – for recording new changes, shows firmware revision.
- 3  User Menu – For increasing values.
- 4  User Menu – For decreasing values and viewing inlet flow on the LCD first line, outlet flow on the second line. A troubleshooting aid to compare sensor values.
- 5  Push once to force the shut-off valve open; push again to return to normal operation.
Caution: Unit will not shut off water, but will send alarm fault when cap loss is detected.
- 6  Push to manually restart after Fault or push to exit from User Menu.
- 7  +  Factory default values. Press ENTER first. Press and hold PROGRAM (holding both buttons together). The unit will enter Factory Reset. When the dots on the LCD reach the end of the line the unit restores all of its factory set points. When “DONE” is displayed, release the buttons.

INDICATOR LIGHTS, PROGRAMMING KEYPAD, AND LCD MESSAGES EXPLAINED - CONTINUED

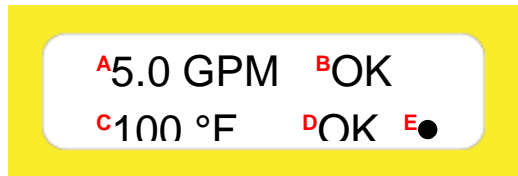

LCD, 2 line x 16 character backlit alphanumeric

- A The current amount of water flow through the Supply side. Return side water flow is not displayed but it is always close to Supply side; otherwise, a leak fault would occur. Expressed in GPM or LPM; the amount can vary per unit used.
- B The status of the current water flow: OK, Low, Min or Fault. When in Fault condition, unit sends alarm to weld controller.
- C The current temperature of the water. Expressed in Fahrenheit or Celsius.
- D The status of the current water temperature: OK or Fault.
- E Heartbeat DOT: Flashing DOT means the flow is being monitored and results displayed.

Power-up

Unit starts out by displaying:

"DELTAPOINT DC2.1"

"4100 11-19-2007"

After 2 second, the second line shows "RESTART 1, 2, 3"

After 5 seconds the unit enters RUN mode and starts monitoring flow and temperature. The 5-second startup is not user adjustable.

Faults

Leak: Closes the valve, sends the corresponding fault signal to PLC/Robot Controller.

No-Flow: Closes the valve, sends the corresponding fault signal to PLC/Robot Controller.

Temperature: Does not close the valve, no fault signal to PLC/Robot Controller. (Green LED (Flow OK) flashes in temperature fault.)

LCD messages

MIN FLOW, FLOW OK, LEAK RATE, OVER / UNDER TEMPERATURE, RESPONSE TIME, RESTART DELAY and UNITS explained further in manual.

Heartbeat - DOT

No flashing means flow is no longer being monitored (reset is needed).

INDICATOR LIGHTS, PROGRAMMING KEYPAD, AND LCD MESSAGES EXPLAINED - CONTINUED

Bypass Button (Electronic)

CAUTION PLEASE NOTE

ONCE THE ROCON / DELTAPOINT UNIT IS PLACED IN BYPASS, THE OPERATOR IS CHOOSING TO IGNORE THE MONITORING OF THE WATER FLOW TO THE CELL (IE – WATER OFF OR LEAK). THEREFORE ROCON IS THEN RELIEVED OF RESPONSIBILITY FOR ANY RESULTING PERSONAL OR EQUIPMENT DAMAGE.

Note: Unit must be restarted after a fault, even if bypass has opened the valve to allow water flow. This allows the faults to reset, and the unit to resume monitoring.

When in bypass, the unit will energize and continue to energize the solenoid shutoff valve; and the shutoff valve will remain on until the bypass button is re-pushed or the unit is reset locally.

If the unit is placed in bypass and a fault occurs, water will continue to flow, however the Min Flow bit will turn off and the “fault” LED will be flashing. The “Bypass” and “OK to Weld” bits will remain on, allowing the robot to weld.

Bypass Button (Manual)

The shutoff valve has a manual override thumb wheel that is turned force water flow. It renders the water saver useless, but if water is available, it will flow at what ever flow rate is available.

Water Shutoff

Leak or No-flow faults cause the water to shut off de-energizing the solenoid. Once faulted the unit will need to be reset.

The robot controller can also remotely shutoff the water via the solenoid interrupt (pink wire) in the event of an emergency.

Reset

There are two ways to reset the water saver-locally or remotely. Both will restart the unit after it goes through the restart delay.

Locally – the water saver can be restarted by pushing the RESET button on the face of the unit.

Remotely – the water saver can be restarted by the robot controller by a REMOTE RESET command.

INDICATOR LIGHTS, PROGRAMMING KEYPAD, AND LCD MESSAGES EXPLAINED - CONTINUED

Viewing Flow Comparison Values

Supply and Return flows can be viewed simultaneously to aid in Sensor Verification/Troubleshooting.

Supply
Return

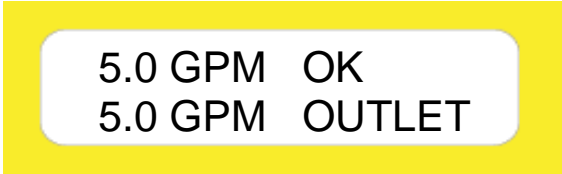

5.0 GPM OK
5.0 GPM OUTLET



(Push and hold)

Viewing Firmware Revision

Firmware revision displayed at power up or by the Enter button..



DELTAPOINT DC2.1
4100 11-19-2007



(Push and hold)

Factory Reset

To change all the set points back to the original factory values, proceed as follows:

- In Run mode, push and hold ENTER.
- While holding ENTER, push and hold PROGRAM.
- The LCD will show "Factory Reset" on Line 1 followed by "..." on Line 2. After 5 seconds, the LCD displays "DONE", release pushbuttons. The unit reverts back to the original set points. See FACTORY SETPOINTS.

PROGRAMMING - USER MENU

Press the PROGRAM button on the keyboard to enter the User Menu.

- The PROGRAM button is used to enter or skip each individual menu. For example, to change Response Time, push PROGRAM 6 times until Response Time is displayed.
- In any of the above menus, if no buttons are pushed for 5 seconds, the User Menu reverts back to Run mode.

REFERENCE

STANDARD FACTORY SETPOINTS

Parameter	12 GPM	
	Range	Factory Set point
Flow OK	1.0 - 12.0	2.4 GPM
Min Flow	0.8 - 11.5	1.8 GPM
Low Flow	Not adjustable	<1.5 GPM
Leak Rate	0.5 - 1.0	0.5 GPM
Fault Temp.	45 - 210° F	65/95° F
Response Time	.5 - 3.0 sec	1.0 sec.
Restart Delay	1.0 – 9.0 sec.	20.0 sec.
Engineering Units	English -Metric	English

Set Min Flow

Push PROGRAM button, the MIN FLOW setting window will appear.

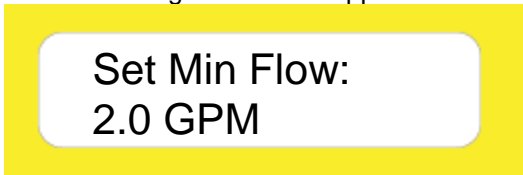

What is Displayed:

2.0 GPM

Current set point

Adjustable Range:

12 GPM: .8 – 11.5 GPM in 0.1 increments

- To change this value, use the UP and DOWN arrows. When the desired value is selected, push ENTER to record in memory. SET will be displayed on the LCD, and then the FLOW OK setting window will appear.
- To skip this menu and go to the next, push PROGRAM.

PROGRAMMING - USER MENU CONTINUED

Set Flow OK

The MIN FLOW value must change to enter into the FLOW OK screen.
Please Note: MIN FLOW must be 0.5 GPM less then FLOW OK value.

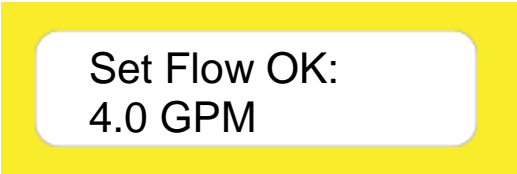

What is Displayed:

4.0 GPM	Current set point
Adjustable Range:	12 GPM: 1.0 – 12.0 GPM in 0.2 increments.

- To change this value, use the UP and DOWN arrows. When the desired value is selected, push ENTERS to record in memory. SET will be displayed on the LCD, and the LEAK RATE setting window will appear.
- To skip this menu and go to the next, push PROGRAM.

Set Leak Rate



What is Displayed:

1.0 GPM	Current set point
Adjustable Range:	12 GPM: 0.5 – 1.0 GPM in 0.1 increments
	<u>Note:</u> Setting the leak rate to a higher value prevents false errors.

- To change this value, use the UP and DOWN arrows. When the desired value is selected, push ENTER to record in memory. SET will be displayed on the LCD and the HIGH TEMP setting window, followed by the LOW TEMP setting window will appear.
- To skip this menu and go to the next, push PROGRAM.

PROGRAMMING - USER MENU CONTINUED

Set Over / Under Temperature



What is Displayed:

150 °F

Current set point

Adjustable Range:

45 F – 210 F in 5 degree increments

What Happens:

When water temperature in the return leg is over/under this value, the LCD displays "Fault" and the fault signal is transmitted to the weld controller. The Green FLOW OK, LED on the membrane also flashes.

- To change the OVER TEMP value, use the UP and DOWN arrows. When the desired value is selected, push ENTER to record in memory. SET will be displayed on the LCD and repeat UNDER TEMP once complete the RESPONSE TIME setting window will appear.
- To skip this menu and go to the next, push PROGRAM.

PROGRAMMING - USER MENU CONTINUED

Set Response Time

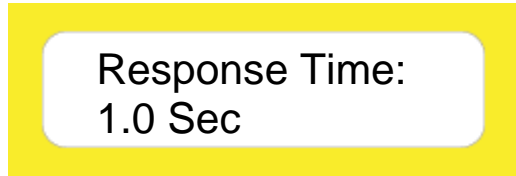

What is Displayed:

1.0 Sec	Current set point
Adjustable Range:	0.5 – 3.0 seconds in 0.5 increments

What Happens:

DeltaPoint tries to look for a Leak Fault within this timeframe. For higher values, the flow readings are averaged internally for the defined period. This may be a good idea to prevent false errors.

- To change this value, use the UP and DOWN arrows. When the desired value is selected, push ENTERS to record in memory. SET will be displayed on the LCD, and the RESTART time setting window will appear.
-
- To skip this menu and go to the next, push PROGRAM.

Restart Delay

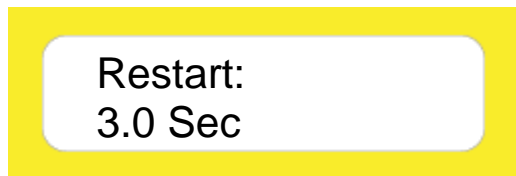

What is Displayed:

3.0 Sec	Current set point
Adjustable Range:	1 – 3.0 seconds in 1.0 second increments

Note: There is an additional 3-second delay at power-up associated with displaying the firmware banner. This delay is bypassed if a remote restart is sent to the instrument.

What Happens:

At power up, DeltaPoint waits this long before it starts monitoring the water flow. This is the time that it takes for water flow to stabilize throughout the circuit after the solenoid valve is opened, and for removing all trapped air in the water line after a cap is replaced. Short delays may result in a mismatch between the Supply and Return flow readings, thus issuing an incorrect Fault signal.

- To change this value, use the UP and DOWN arrows. When the desired value is selected, push ENTER to record in memory. SET will be displayed on the LCD, and the UNITS setting window will appear.
- To skip this menu and go to the next, push PROGRAM.

PROGRAMMING - USER MENU CONTINUED

UNITS

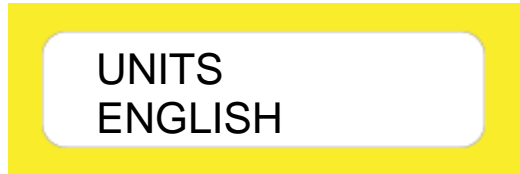

What is Displayed:

English	Current setting
Selectable	English or Metric

What Happens:

The display will be in GPM / F for English or
LPM / C for Metric

- To change this value, use the UP and DOWN arrows. When the desired value is selected, push ENTER to record in memory. SET will be displayed on the LCD, and the UNITS setting window will appear.
- To skip this menu and go to the next, push PROGRAM.

ELECTRICAL CONNECTORS

“P”

FACE VIEW OF CABLE END

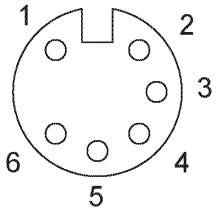

FEMALE

FACE VIEW OF CONNECTOR

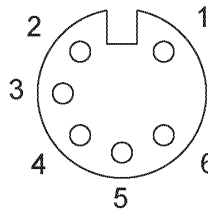

MALE

BOX CON #2

CONNECTOR #2

- 1 BRN = +24VDC
- 2 WHITE = DC GROUND
- 3 BLU = CHASSIS GRND
- 4 BLK = REMOTE RESET
- 5 GRY = ALARM OUT
- 6 PNK = E STOP

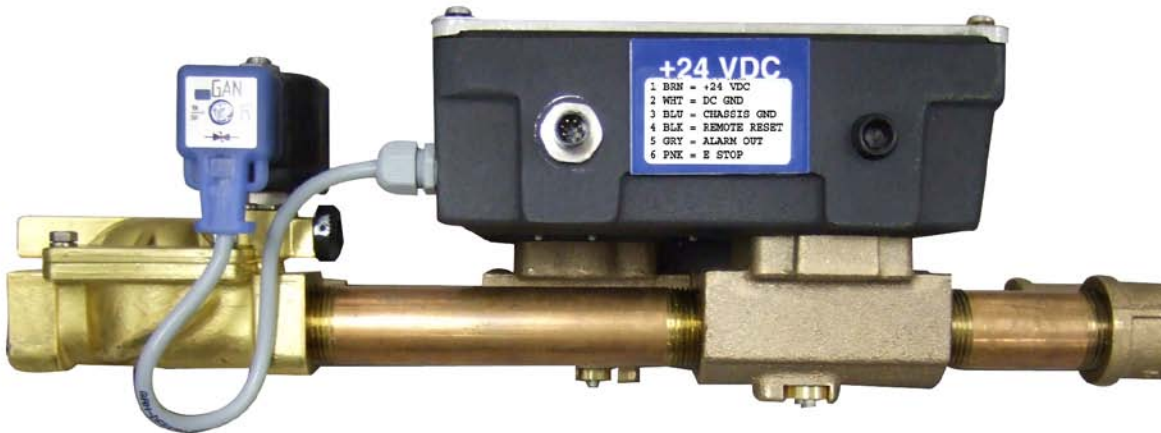

MAINTENANCE

DeltaPoint water savers require no maintenance. If the flow tubes become clogged with debris, the unit should be removed for service and cleaning. Significant clogging may result in erratic operation, errors or faults. Do not place tools into the tubes, as this may permanently damage the vortex sensor. The vortex sensor *cannot* be repaired.

To clean the flow tubes, remove the shut-off valve and check valve. Run clean water into the downstream end of each leg. Large objects jammed against the bluff body may be dislodged by lightly tapping the upstream end of the flow tube against a firm surface. **CAUTION: Do not tap the flow tube too hard or damage may occur.**

Shut-Off Valve

The manufacturer recommends that the diaphragm be removed and cleaned periodically. The operation of the valve is based on small orifices functioning properly. Depending on the level of water contamination, cleaning frequency could vary from monthly to yearly. If a low-maintenance type valve is required and air is available, please contact factory and request information on the air-operated shut-off valve.

Check Valve

If check valve is leaking, it may be disassembled and cleaned.

See [APPENDIX](#) for information on this valve.

Cleaning

These meters do not require any special cleaning of the external surfaces. If cleaning is deemed necessary, strong solvents, detergents, or chemicals should not be used. A damp cloth may be used to wipe off dirt or debris.

Note

If used outside the parameters specified in this manual, the proper operation of the flowmeter cannot be guaranteed.

TROUBLESHOOTING

	PROBLEM	EXPLANATION/SOLUTION
1	LCD blank, no LEDs	Power not present. Check power cable.
2	LCD Line 2 "Return > Supply"	Refer "LINEARITY TESTING"
3	DeltaPoint does not respond to remote shut-off and/or restart commands from robot controller (RC)	Check the Robot Controller to make sure they are properly terminated. Check the cable. Simulate within the watersaver at terminal strip.
4	DeltaPoint continuously restarts	A Restart signal was sent via robot controller and the request is still active.
5	DeltaPoint does not respond to remote shut-off and/or restart commands from plc	Check the PLC to make sure
6	DeltaPoint continuously restarts	A Restart signal was sent via PLC and the request is still active.
7	DeltaPoint restarts and shows flow briefly, then proceeds to shutdown	The return sensor affected by debris or malfunctioning Refer – " COMPARISON TESTING " and " SUPPLY FLOW IS GREATER THAN RETURN FLOW ". If either sensor is misreading, first flush the Bluffs, then work on sensors.
8	Comparison Testing	The test is performed by pressing the "DOWN" Arrow button on the front cover. It can be pressed at any time during operation. The display shows both supply/return flow rates, if the difference is greater than 0.5 GPM (return being lower), then there might be a problem with the return sensor. Refer " REPLACING THE SENSOR "

- 9 Flushing the Bluff
- Procedure to flush the Bluff Chamber:
Step 1 – Closed both Supply/Return ball valves. Bleed off the water pressure by loosening a hose downstream or pulling a weld gun arm cap.
Step 2 – Using a 3/32 Allen Head Wrench remove both Bluffs' hold down screws. Remove bluffs, is there debris on bluff – remove.
Step 3 – Solenoid Valve – switch to BYPASS position.
Step 4 – Tighten the bleed off hose fitting or replace cap.
Step 5 – Supply Ball Valve – With the bluffs removed flush the sensor bodies by partially opening the valve and spraying with short bursts for 10 seconds to flush out the bodies. Any contamination build up should have been removed.
Step 6 – Reverse above steps and activate the Unit for proper operation.
- 10 Water doesn't shutoff.
- Once both shutoff devices are closed (no electrical power).
Step 1 - Partially open the supply ball valve. If the water flows, then there is a problem with the solenoid valve.
Step 2 - If the water does NOT flow, shut the supply ball valve off.
Step 3 - Partially open the return valve. If the water flows, then there is a problem with the check valve.
- 11 Solenoid Valve Problem
- Solenoid Valve will not shutoff the water:
Step 1 - Check the manual override on the valve. Confirm that it is in the NORMAL OPERATION position. Refer to APPENDIX Shutoff Valve Specification. The valve could have debris blocking the balancing orifice or the Plunger Assembly is stuck in the open position in the Sleeve Assembly.
Step 2 - Remove the coil / Din connector assembly. Remove the 4 screws holding the cover to the body. Turn cover over and insert a thin wire in the balance hole (farthest from the manual bypass knob) to insure that the orifice is not blocked.
Step 3 – Remove the Sleeve Assembly. The internal parts will be the Plunger and Plunger Spring. Do they move up and down freely? If NO then clean or replace with new Sleeve Assembly.
Step 4 - Replace the valve cap and the coil, reassemble and confirm that this has resolved the problem by removing another tip.
- 12 Check Valve Problem
- Check Valve will not shut off the water.
Step 1 - The only way to remove the debris is to change out the check valve with a replacement and then clean out the check valve on the bench.
Step 2 - Remove the snap ring and push the piston out to remove any debris.
Step 3 - Replace the new check valve with the cleaned valve, reassemble and confirm that this has resolved the problem by removing another tip.

- 13 SUPPLY FLOW is greater than RETURN FLOW (UNIT CONTINUOUSLY FAULTS OUT) This is either debris on the return bluff or a “return sensor” problem. Refer “**COMPARISON TESTING**” and “**FLUSHING THE BLUFF**”.
- 14 RETURN FLOW is greater than SUPPLY FLOW This is either debris on the supply bluff or a “supply sensor” problem. Refer “**COMPARISON TESTING**” and “**FLUSHING THE BLUFF**”.
- 15 Replacing the Sensor Procedure to replace the a sensor:
Step 1 - Remove Power Cable.
Step 2 - Turn off the water and bleed off the pressure by loosening the hosing downstream (drains water out of sensor chamber, preventing water leaking into electrical box).
Step 3 – Remove the Cover – slotted screw driver.
Step 4 – Remove the Key Pad circuit board – slotted screw driver.
Step 5 – Remove the LCD screen – #2 Phillips screw driver.
Step 6 – Remove screws from hold-down bracket of the sensor to be swapped – Phillips screw driver.
Step 7 - Using a pair of needle nose pliers, remove the sensor. (Note the position of the “slot” in the sensor is vertical, following the flow).
Step 8 – Install new sensor and o ring assembly with needle nose pliers. **CAUTION:** Sensor SLOT must be aligned “perfectly” with the water flow direction. Slot can be rotated 180 degrees.
Step 9 - Replace the hold down bracket and screws, wipe down any water.
Step 10 – Replace the LCD screen, Key Pad and Cover.
Step 11 – Confirm the bleed off fitting is tight and the Supply/Return water ball valves OPEN.
Step 12 – Plug in the Power and Ethernet cables
Step 13 - Re-evaluate the unit. Push the “DOWN” Arrow.
ADVANCED TRAINING NEEDED FOR FOLLOW:
 Adjusting the replaced sensor’s flow rate to match the other sensor’s flow rate by turning the sensor pot. The flow rates should be within 0.1 of a gallon of each other. Contact factory for training.

16 If all else fails

If both sensors are drastically off the expected flow (by more than a gallon) and it appears that there is a major problem. You have 2 options:

Option 1 ship the unit to Rocon for recalibration or

Option 2 Rocon can furnish electronics "kit," which will have the motherboard and both sensors. This would be equivalent to replacing the entire unit.

To replace the motherboard with its accompanying sensors (S or I=Supply and R or O=Return):

Step 1 – Shut off the supply/return water ball valves

Step 2 - Remove Power cable.

Step 3 - Remove the LCD display (4 Phillips head screws) and keypad (2 slot head screws).

Step 4 - Unplug all sensors (2 flow and 1 temp).

Step 5 - Remove the 2 slot head screws and 1 Phillips head screws holding the mother board to the box.

Step 6 – Remove the Keypad standoff.

Step 7 – Remove motherboard

Step 8 – Remove supply sensor hold down bracket and pull the sensor assembly out. Label with tape SUPPLY.

Step 9 – Remove the return sensor as describe in step 8.

Step 10 - Replace the sensors from the kit, follow the same procedure as describe in "**Replacing the Sensor**"

Please note Kit – Supply/Return Sensor must be installed in their respective chambers.

Step 11 – Install the Kit Motherboard, Keypad and LCD screen as describe above.

Step 12 - Reconnect the power cables.

The unit should be operating properly.

If not, refer to "**Flushing the Bluff**".

Consult factory if problem.

17 Bypass

There are both electronic and manual bypasses on the units. The electronic bypass is a button on the face of the unit, and once pushed energizes the solenoid valve coil. The coil will continue to be energized, until the bypass button is pushed again.

The manual bypass overrides the solenoid coil completely. It does not give a signal to the robot and water flow is maintained, regardless of the unit's status.

DIMENSIONS

Unit shown with Mounting Bracket / Shut off Valves in bottom position

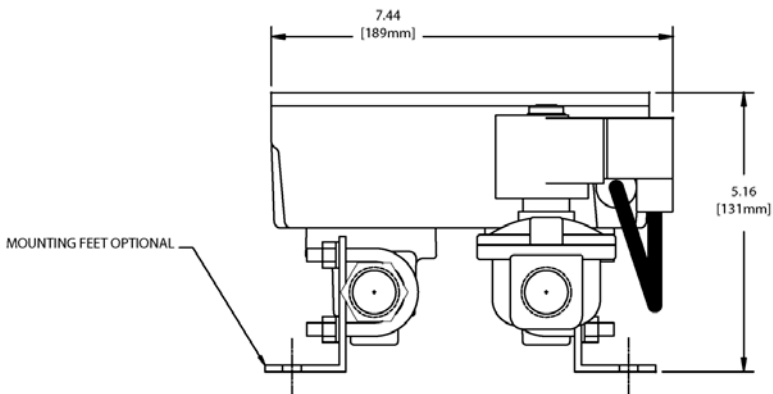
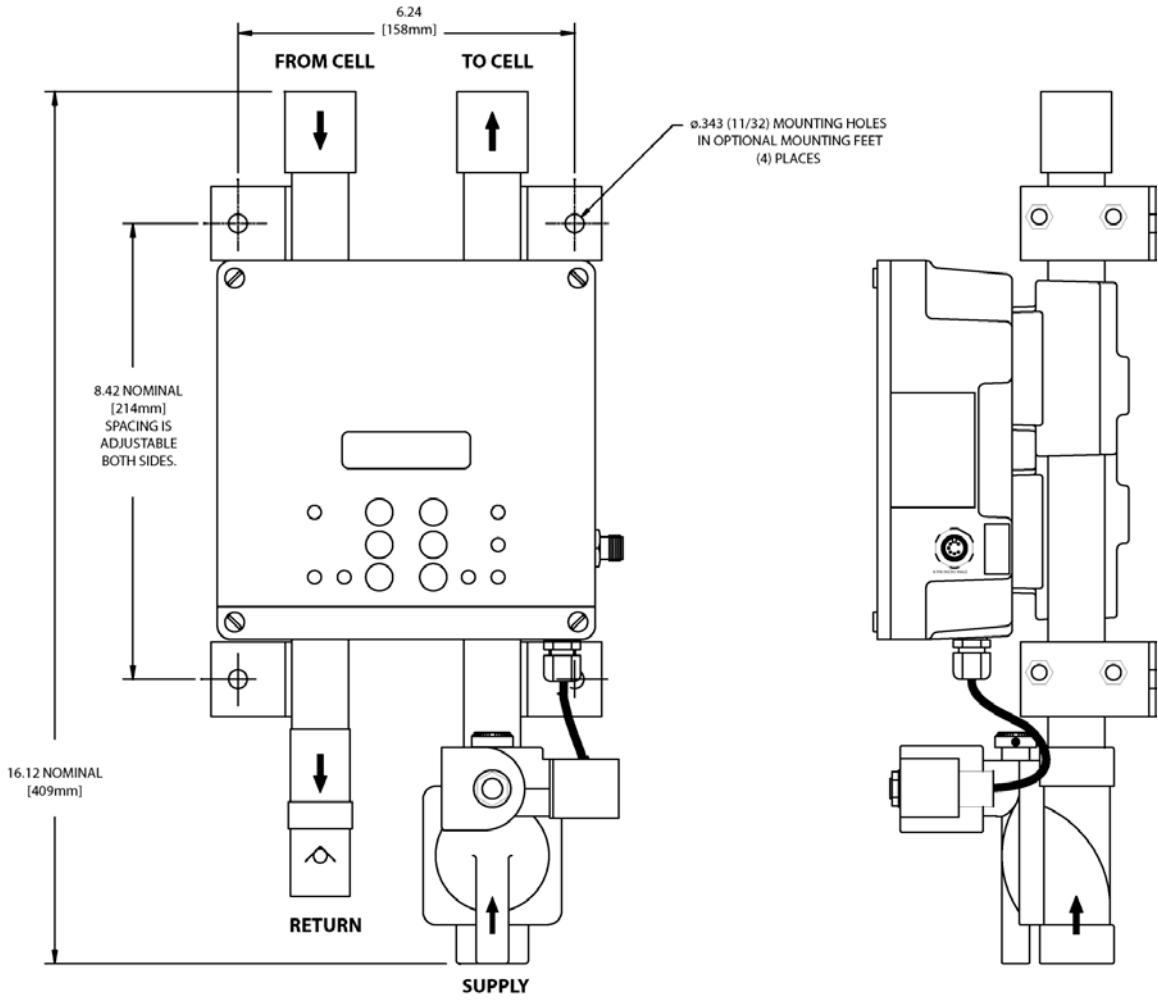

Unit shown with Shut off Valves in top position. "X" in model code indicates water feed from the top.

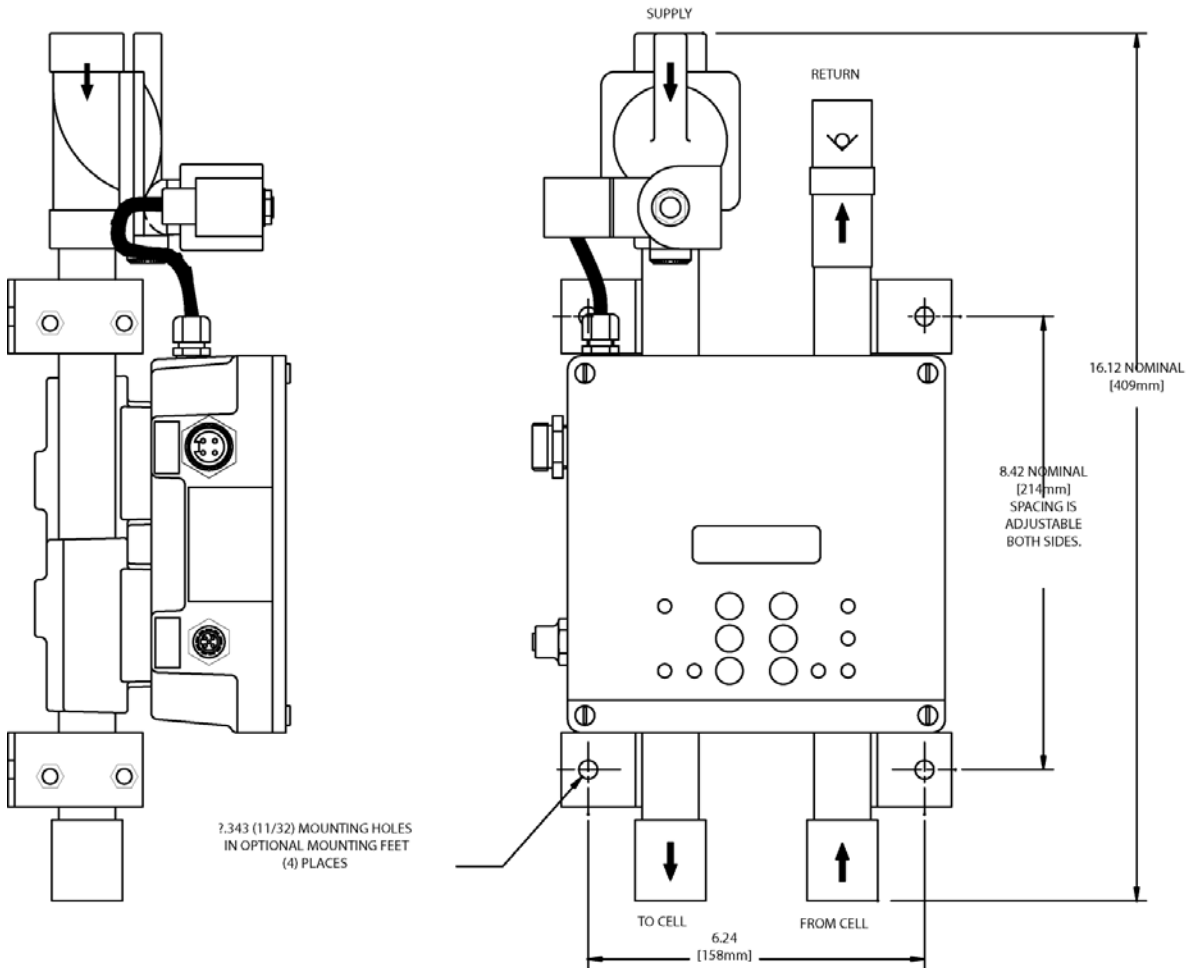
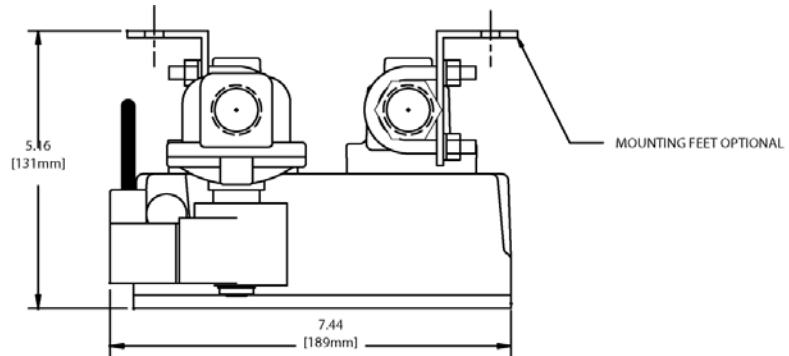

MODEL CODES

Delta Point TM

HOW TO ORDER

Select the appropriate symbols to build a model code:

EXAMPLE: DPL - B - 6 - **E**

FLOW RANGE	
0.5 - 6.0 GPM / (1.9 - 11.4 LPM)	= D
0.8 - 12.0 GPM / (5.7 - 45.4 LPM)	= B

PORT SIZE	
3/4 NPTF	= 6
3/4-14 BSPP	= 12G

UNIT TYPE	
DC	= D
DeviceNet	= N
EtherNet	= E

****E 4 digit code assigned at factory per plant location and company specification

APPENDIX

Topic – New Install, Protecting Sensor from Water Hammer failure.

Definition - Water hammer (or, more generally, fluid hammer) is a pressure surge or wave resulting when a fluid in motion is forced to stop or change direction suddenly (momentum change). Water hammer commonly occurs when a valve is closed suddenly at an end of a pipeline system, and a pressure wave propagates in the pipe. It may also be known as hydraulic shock. This pressure wave can cause major problems, from noise and vibration to pipe collapse. The pressure wave that propagates when a valve is opened acts in exactly the same fashion but this wave behaves differently in an empty vs full pipe system. In a full pipe system the wave is controlled by the fact that the wave causes the fluid to begin flowing and in a full pipe the velocity of the wave is controlled by the restrictions in the flow path that regulates the movement of the fluid. Which results in normal system velocities. When a valve is opened in an empty pipe system no such restrictions are present and the resulting flow wave is only regulated when the fluid meets a restriction of some sort and slows this wave. Resulting in very high velocities with correspondingly high flow rates. These flows are limited only by the amount of water that will flow at 80PSI through the ¾" pipe system this leading edge of the flow system, which can be moving at velocities exceeding 40 or 50 ft/sec and thusly acting like a water hammer on our sensor and potentially damaging it. Normally only effects the supply water leg of the circuit because the water velocity is slowed down as it travel through the weld gun arms. CAUTION: Each time the pump is turned off and on care should be taken to prevent this shock wave from occurring again.

Suggested change needed to protect sensor from water hammer:

A – Supply water ball valve closed to the DeltaPoint "L" Units when turning cooling water pump ON. Only opened the ball valve when the system water flow has stabilized.

B – Do not exceed 150% of max flow rating IE Max Flow Rating = 12 GPM, do not exceed 18 GPM.

Manual Reference: Page 12, Item 8 and 10.

Check Valve Specifications

Style: Piston Check Valve with embedded O-ring that seals on seat
 Maximum operating pressure: 500 PSI (34.5 bar)
 Maximum operating temperature: 180 °F (82 °C)
 Cracking Pressure: 1 PSI
 Material: Brass Body and Piston, Beryllium Copper Ring

Shut-Off Valve Specifications

Function: 2-Way Normally Closed
 Ports: 3/4" NPT
 Pressure Range: 2 PSI to 150 PSI (0.14 bar to 10 bar)
 Temperature Ratings:
 Ambient: 14 °F to 122 °F (-10 °C to 50 °C)
 Fluid Media: 176 °F (80 °C) Maximum
 Coil Power Rating: 24VDC @ 750 mA (16 Watts) Maximum
 Electrical Connector: DIN Style Plug w/ Removable Cable Plug Adaptor
 Materials of Construction:
 Body: Brass
 Seal: Buna N
 Other Wetted Parts: Stainless Steel, PVDF, Brass
 Coil: Class F, Molded, Continuous Duty, UL & CSA Listed

Contact Factory for Spare Parts

Manual Override (Bypass)

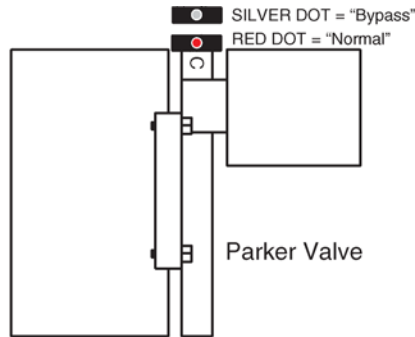

MANUAL OVERRIDE

Rotate knob 180 degrees to either position
 Starting point - "C" stamped on valve body.

PARKER VALVE

RMA NOTICE RETURN MATERIAL AUTHORIZATION

Please read the following UFM policy information carefully. By following the guidelines outlined below you will assist in providing a timely evaluation and response regarding the status of your flow meter. UFM evaluates all AUTHORIZED RETURNED MATERIALS in a timely manner and will promptly provide notification regarding the status of the related materials and/or a written quotation indicating the total charges and description of the necessary repairs.

- 1 All returns must have a RMA form completed by the customer.
- 2 Any meter returned that was previously in service must have the OSHA requirements completed and a MSDS included where applicable.
- 3 An RMA number will only be issued when UFM has received a copy of the completed RMA form and any applicable MSDS.
- 4 A "Return Goods" shipping label (located in the back of the Instruction Manual) must be used for returning materials to UFM.
- 5 Returned goods must be shipped prepaid or they will be rejected.

REPAIRABLE MATERIAL

Written or verbal authorization to proceed with the repair under an assigned Purchase Order, must be received within 30 days of repair quotation. If the unit(s) is repaired, the \$90.00 evaluation charge will be applied to the quoted repair costs. If no repairs are authorized within this 30 day period, the customer will be billed \$90.00 plus shipping charges and the materials will be returned to the customer.

NON-REPAIRABLE MATERIAL

If materials are found not repairable, a written notice that the material is not repairable will be provided to the customer by UFM. If no disposition to scrap or return the material is received from the customer within 30 days, unrepairable material will be scrapped and the customer will be billed the \$90.00 evaluation charge. If a UFM replacement unit is purchased within 30 days of non-repairable condition notice, the \$90.00 evaluation fee will be waived. The return of non-repairable materials may be ordered by customer Purchase Order providing for shipping and handling charges.

RETURN FOR RESTOCK All goods returned for restock adjustment **must** be:

- A. New and unused.
- B. **Returned to the factory within ONE YEAR of date of original shipment.**
- C. Returned through the distributor where the goods were originally purchased. This material will also be subject to an evaluation charge of \$90.00.

The customer will be advised of the restocking adjustment for all restockable goods. Upon acceptance of the restocking adjustment, by the customer, the \$90.00 evaluation fee will be waived and a credit issued by UFM. The customer will be advised of any **non-restockable** goods and will be charged the \$90.00 evaluation fee plus any shipping charges if returned to the customer.

If no disposition is received by UFM within 30 days, the goods will be scrapped and the \$90.00 evaluation fee will be billed.

WARRANTY RETURNS

Warranty returns must be shipped prepaid to UFM. UFM will review the goods and advise the customer of the evaluation and validity of the warranty claim. Valid warranty claims will be repaired or replaced at no charge. No evaluation fee will be charged for repairs made under warranty. Return shipping costs will be prepaid by UFM. Should UFM determine the returned material is not defective under the provisions of UFM's standard warranty; the customer will be advised of needed repairs and associated costs. All materials returned for warranty repair that are determined to not have a valid warranty claim will be subject to the "**Repairable Material**" policy outlined above.

RMA FORM

<p>UNIVERSAL U M ROCON LLC FLOW MONITORS</p>	<p>RETURN MATERIAL AUTHORIZATION E-MAIL: ufm@flowmeters.com 1755 E. Nine Mile Rd., Hazel Park MI 48030 PH: (248) 542-9635 Fax: (248) 398-4274</p>
---	--

IMPORTANT: This form must be filled out completely and faxed to the Repair Department prior to issuing a RMA # (UFM) / NRA # (ROCON)

Customer: _____	Product Information	Qty: _____
_____	Model Code: _____	_____
_____	S/N: _____	_____
_____	Sales Order: _____	_____
Contact Name: _____	_____	
Phone # _____	_____	
FAX # _____	Are before (as found) and after readings required?	
E-mail: _____	_____ Yes _____ No	
Reason for return: (Please be detailed as possible. Lack of Information may increase labor charges.)		
<p>Mechanical</p> <input type="checkbox"/> Leaks <input type="checkbox"/> Sticks <input type="checkbox"/> Calibration Off <input type="checkbox"/> Switch does not work <input type="checkbox"/> Other (describe below)	<p>Electronics</p> <input type="checkbox"/> No signal <input type="checkbox"/> Inaccurate signal <input type="checkbox"/> No Display <input type="checkbox"/> Other (describe below)	
Details: _____		

<p>Note: There will be a minimum evaluation charge of \$90.00 for all units returned (excluding units covered under warranty). Units WILL NOT be accepted without a valid Return Material Authorization Number (RMA#). A Material Safety Data Sheet on the process fluid must be received, when applicable, prior to the RMA# being issued.</p>		
<p>* OSHA Requirements: (to be filled out by customer) NO EXCEPTIONS!!</p>		
Process Fluid: _____		
Meter must be flushed to remove all process fluids.		
I hereby certify that the material being returned has been properly flushed and cleaned of all hazardous materials and does not require any special handling.		
Print or Type Name _____	Signature: _____	
Title _____	Date: _____	

<p>Distributor Information INTERNAL USE ONLY</p> <p>Company Name _____</p> <p>Contact Name _____</p> <p>PO # _____</p> <p>Phone # _____ FAX # _____</p>	<p># _____</p> <p>Authorized by _____</p> <p>Date _____</p>
---	---

ROCON / DELTAPOINT WARRANTY

1) ACCEPTANCE AND INTEGRATION CLAUSE: This Sales Order Acknowledgment and the sales order information that Rocon LLC attaches to or associates with it (this "Acknowledgement"), constitutes an acceptance by Rocon of an offer by the buyer upon the conditions and terms and at the prices stated in this Acknowledgement. This Acknowledgment contains the entire understanding of Rocon and the buyer regarding the subject matter of this Acknowledgement. This Acknowledgement may only be modified by a writing signed by the party against whom enforcement is sought.

2) WAIVER: Waiver by Rocon of any default(s) by the buyer shall not constitute waiver by Rocon of any of the conditions of the agreement between Rocon and the buyer as set forth here under with respect to any further or subsequent default by the buyer.

3) FORCE MAJEURE: Rocon shall not be responsible for failure or delays in deliveries due to fire, strikes, breakdowns, acts of God, failure of carriers, inability to secure required materials, or other causes beyond Rocon's control. Buyer waives any claims for damage arising by virtue of delay in delivery of material by Rocon.

4) LIMITED WARRANTY:

(a) Warranty: For a period of one year from the date of manufacture, Rocon warrants that each product covered by this Acknowledgement will be free from defects in material and workmanship. In order to qualify for any remedy provided in this Acknowledgement, buyer must give notice to Rocon within the one-year period, return the product to Rocon freight paid and intact with Material Safety Data Sheets covering all substances passing through the product or that form a residue on the product.

(b) Exclusive Remedy. The buyer's EXCLUSIVE REMEDY for failure of any product to conform to any warranty or otherwise for any defect is, at Rocon's sole option, (i) repair, (ii) replacement, or (iii) refund of the entire purchase price for the specific product. Without limiting the foregoing, in no case will Rocon be liable for deinstallation of any defective product or installation of any repaired or replacement product THIS REMEDY IS THE EXCLUSIVE REMEDY AVAILABLE TO THE BUYER OR ANY OTHER PERSON. ROCON SHALL NOT BE LIABLE FOR ANY DIRECT, INDIRECT, INCIDENTAL, CONSEQUENTIAL, SPECIAL, PUNITIVE, OR OTHER DAMAGES IN CONNECTION WITH ANY CAUSE OF ACTION, WHETHER IN CONTRACT, TORT, OR OTHERWISE.

(c) Disclaimer of Other Warranties. The express warranty in this Acknowledgement is in lieu of any other warranty, express or implied. Without limiting the foregoing, ROCON DISCLAIMS THE IMPLIED WARRANTY OF MERCHANTABILITY AND ANY IMPLIED WARRANTY OF FITNESS FOR A PARTICULAR PURPOSE.

5) Products purchased by OEMs (original equipment manufacturers) are warranted only for the specific programs (installations for specific customers) designated when so identified.

6) Flow sensors are warranted for 5 years, electronic parts for 2 years and ancillary check valves and shut off valves for 6 months.