



Topic:	Page	Topic:	Page
1. Quick Start Guide	1	8. Wiring the Magmeter with Frequency or Digital (S ³ L) Output	6
2. Specifications	2	9. Calibration and Software Configuration	6
3. Installation: Pipe Fittings	3	10. Calibration Data	7
4. Selecting a Location	3	11. Maintenance and Troubleshooting	11
5. Hardware Configuration	4	12. Ordering Information	12
6. General Installation and Grounding Tips	5		
7. Wiring the Magmeter with 4 to 20 mA Loop	5		

Description

The Signet 2551 Magmeter is an insertion-style magnetic flow sensor. The patented sensor design is available in a variety of corrosion-resistant materials to provide long-term reliability and minimal maintenance costs. Wetted material combinations include PP/316 SS, PVDF/Hastelloy-C and PVDF/Titanium. The 2551 installs quickly and securely into a wide selection of flow fittings to deliver accurate flow measurement in pipe sizes ranging from DN15 to DN900 (½ in. to 36 in.).

Signet 2551 Magmeters are available with a frequency output or Digital (S³L) output for use with the Signet 5600 Batch Controller, 8900 Multi-Parameter Controller or 9900 Transmitter, or with a 4 to 20 mA output for a direct input to a PLC, SCADA or telemetry system.

All 2551 Magmeters feature empty pipe detection and LED-assisted diagnostics. The Signet 3-0250 USB to Digital (S³L) set-up tool is available to customize every performance feature in the 2551 to adapt it to the specific application requirements.

1. Quick Start Guide

This manual contains the general installation, wiring and calibration data for the Signet 2551-XX-11 Magmeter with Frequency or Digital (S³L) data output, and for the Signet 2551-XX-12 Magmeter with 4 to 20 mA output. The basic steps are outlined on this page. See each referenced section for detailed information.

1. Configure the Hardware

2551-XX-11 ONLY: Position this Jumper to select Digital (S³L) output or Frequency output. Sec. 5 Pg. 4.

2. Position the PIPE SIZE jumper according to your pipe size. Sec. 5 Pg. 4.

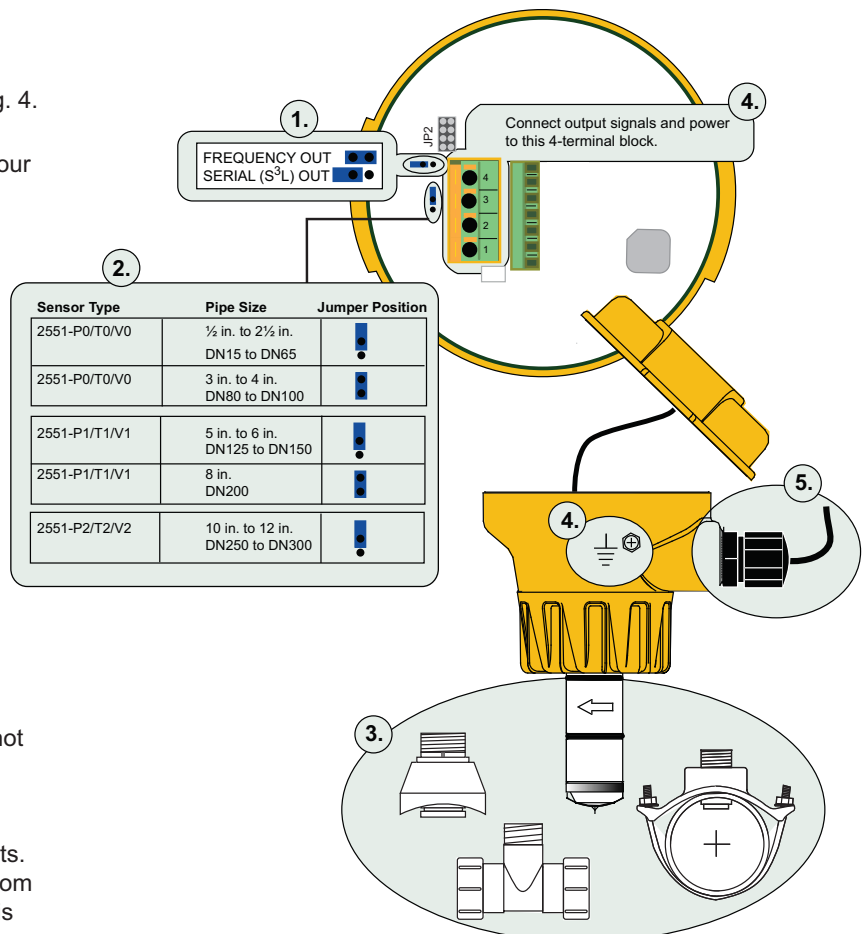

3. Install the Magmeter into the pipe.

Use Signet installation fittings ONLY. The installation fitting is critical to Magmeter performance. Sec. 3 Pg. 3.

4. Connect POWER and OUTPUT wiring.

Frequency out: Sec. 8.1 Pg. 6.
Digital (S³L) out: Sec. 8.2 Pg. 6.
4 to 20 mA out: Sec. 7 Pg. 5.

GROUNDING

Without a good earth ground, the Magmeter may not operate efficiently. Sec. 6 Pg. 5.

5. Route the wiring out through the two cable ports. Use appropriate hardware to secure the 2551 from moisture intrusion. One Liquid Tight Connector is included. Sec. 5 Pg. 4.



SAFETY INSTRUCTIONS

1. Depressurize and vent system prior to installation or removal.
2. Confirm chemical compatibility before use.
3. Do not exceed maximum temperature/pressure specifications.
4. Wear safety goggles or face shield during installation/service.
5. Do not alter product construction.
6. Disconnect power before attempting any service or wiring.

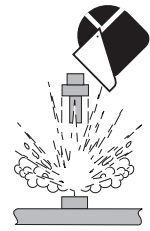

2. Specifications

General

Pipe size range: DN15 to DN 900 (0.5 in. to 36 in.)
 Flow Range
 • Minimum: 0.05 m/s (0.15 ft/s)
 • Maximum: 10 m/s (33 ft/s)
 Linearity: $\pm 1\%$ reading plus 0.01m/s (0.033 ft/s)
 Repeatability: $\pm 0.5\%$ of reading @ 25 °C (77 °F)
 Min. Conductivity: 20 μ S/cm

Wetted Materials:

- Sensor body and Electrodes and Grounding ring:
 - -P0, -P1, -P2: Polypropylene and 316L SS
 - -T0, -T1, -T2: PVDF and Titanium
 - -V0, -V1, -V2: PVDF and Hastelloy-C
 - O-rings: FPM (standard); EPDM, FFPM (optional)

The user is responsible for determining the chemical suitability of these materials for a specific application.

Electrical

Power Requirements

- 4 to 20 mA: 21.6 to 26.4 VDC, 22.1 mA max.
- Frequency: 5 to 26.4 VDC, 15 mA max.
- Digital (S³L): 5 to 6.5 VDC, 15 mA max.

Reverse polarity and short circuit protected

Current output (4 to 20 mA):

- Loop Accuracy: 32 μ A max. error (25 °C @ 24 VDC)
- Isolation: Low voltage < 48 VAC/DC from electrodes and auxiliary power
- Max cable: 300 m (1000 ft.)
- Error condition: 22.1 mA
- Max. Loop Resistance: 300 Ω
- Compatible with PLC, PC or similar equipment

Frequency output:

- Max. Pull-up Voltage: 30 VDC
- Compatible with Signet 5600, 8900, 9900

Digital (S³L) Output:

- Serial ASCII, TTL level 9600 bps
- Compatible with Signet 8900, 9900

Environmental Requirements

- Case: PBT
- Display: Polyamide
- Storage Temperature: -20 to 70 °C (-4 to 158 °F)
- Relative Humidity: 0 to 95% (non-condensing)
- Operating Temperature:
 - Ambient: -10 to 70 °C (14 to 158 °F)
 - Media: 0 to 85 °C (32 to 185 °F)
- Max. operating pressure:
 - 10.3 bar @ 25 °C (150 psi @ 77 °F)
 - 1.4 bar @ 85 °C (20 psi @ 185 °F)

Standards and Approvals

CE, UL
 NEMA 4X / IP65 Enclosure (with cap installed)



China RoHS
 For more information go to www.gfsignet.com



Declaration of Conformity according to FCC Part 15

This device complies with Part 15 of the FCC rules.

Operation is subject to the following two conditions:

- (1) This device may not cause harmful interference, and,
- (2) This device must accept any interference received, including interference that may cause undesired operation.

Dimensions

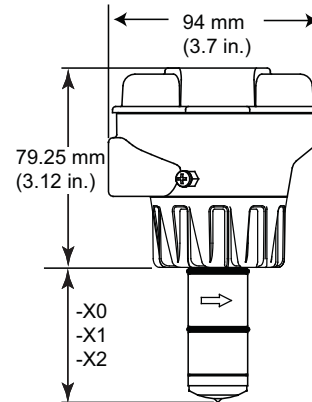

Pipe Range:

- 1/2 to 4 in. -X0 = 58 mm (2.3 in.)
- 5 to 8 in. -X1 = 91 mm (3.6 in.)
- 10 to 36 in. -X2 = 167 mm (6.6 in.)





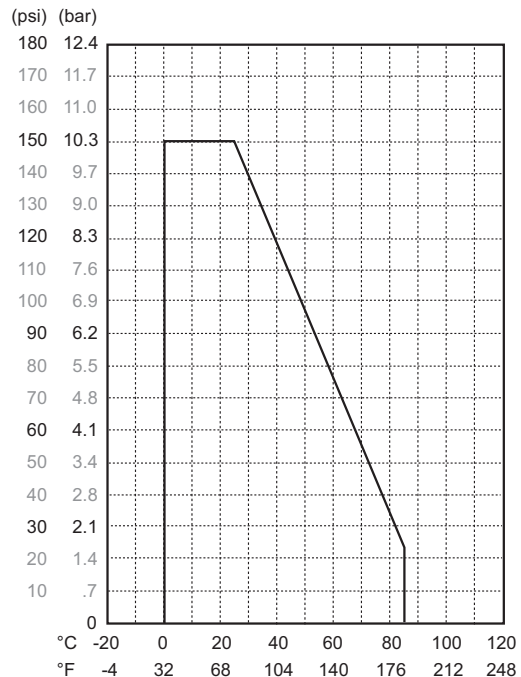

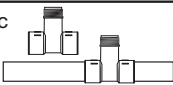

X = Sensor Body P, T, or V

Operating Temperature/Pressure



3. Installation: Pipe fittings

Georg Fischer offers a wide selection of installation fittings that control the position of the Magmeter electrodes in relation to the dimensions of the pipe. You will find a complete list of order numbers for installation fittings in the Calibration Tables on pages 7-10.

Type	Description	Type	Description
 Plastic tees	<ul style="list-style-type: none"> • 0.5 to 2 inch versions • MPVC or CPVC 	 Iron, Carbon Steel, 316 SS Threaded tees	<ul style="list-style-type: none"> • 0.5 to 2 in. versions • Mounts on threaded pipe ends
 PVC Glue-on Saddles	<ul style="list-style-type: none"> • Available in 10 and 12 inch sizes only • Cut 2-1/2 inch hole in pipe • Weld in place using solvent cement 	 Carbon steel & stainless steel Weld-on Weldolets	<ul style="list-style-type: none"> • 2 to 4 inch, cut 1-7/16 inch hole in pipe • Over 4 inch, cut 2-1/8 inch hole in pipe
 PVC Clamp-on Saddles	<ul style="list-style-type: none"> • 2 to 4 inch, cut 1-7/16 inch hole in pipe • 6 to 8 inch, cut 2-1/8 inch hole in pipe 	 Fiberglass tees FPT	<ul style="list-style-type: none"> • 1.5 in. to 2 in. PVDF insert
 Iron Strap-on saddles	<ul style="list-style-type: none"> • 2 to 4 inch, cut 1-7/16 inch hole in pipe • Over 4 inch, cut 2-1/8 inch hole in pipe • Special order 14 in. to 36 in. 	 Union Fittings and Wafers	<ul style="list-style-type: none"> • For pipes from DN 15 to 50 mm • PP or PVDF

4. Selecting a Location

- The 2551 requires a full pipe and a fully developed turbulent flow profile for accurate measurement.
- If the piping system harbors air pockets or bubbles, take steps to locate the sensor so the air pockets will not contact the electrodes.
- In vertical installations, assemble the 2551 so the conduit ports are facing downward. This prevents condensation inside the conduit from being directed into the 2551 electronics housing.
- Chemical injection systems can temporarily alter the fluid conductivity and cause anomalies in the magmeter measurement. To avoid this problem, install the magmeter UPSTREAM of the injection point.

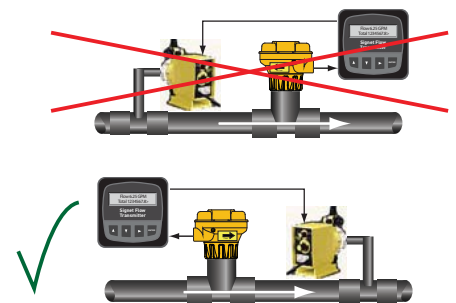

Select a location with sufficient distance of straight pipe immediately upstream of the sensor.

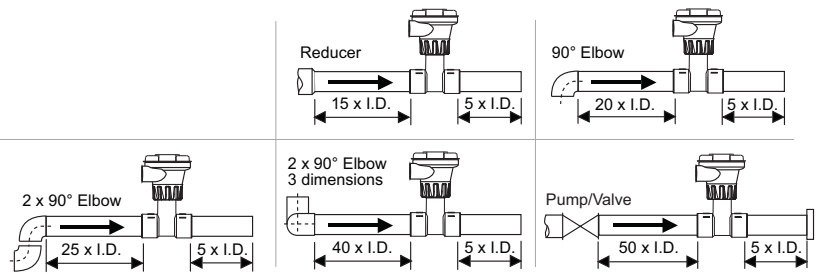

Locating the sensor in a trap or where the flow is upward helps to protect the sensor from exposure to air bubbles when the system is in operation.

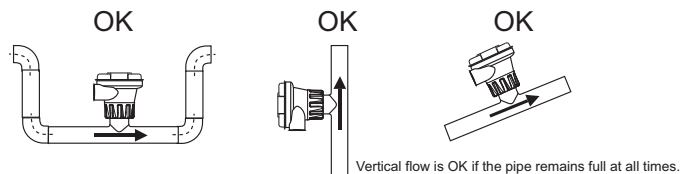

These configurations are not recommended because it is difficult to keep the pipe full.

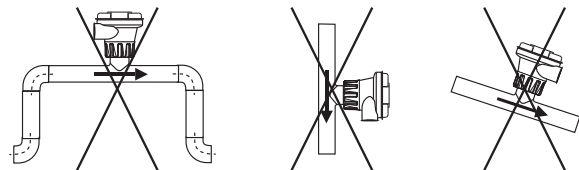

In a gravity-flow system, the tank must be designed so the level does not drop below the outlet.

This causes the pipe to draw air in from the tank. If air bubbles pass across the Magmeter electrodes, the output will become erratic.

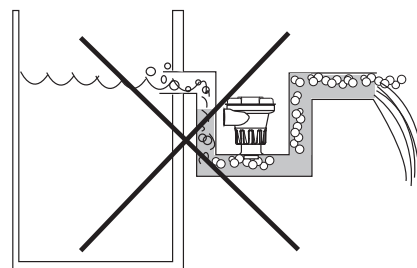

5. Hardware Configuration

Whether using the 2551-XX-11 (with frequency or Digital (S³L) output) or the 2551-XX-12 (with 4 to 20 mA output), the wiring terminals located on the inside of the yellow cover are identical. All of the connections from the Magmeter to external equipment (PLC, Datalogger, Chart Recorder, Flow meter, etc.) are made at the large 4-position terminal connector.

When the cover is removed the wiring from the sensor can be seen connected to the smaller terminal block. These connections should always remain connected to prevent inadvertent damage or miswiring.

The terminals on the 2551 Magmeter are designed for conductors from 16 AWG to 22 AWG.



WARNING!

If the second conduit port is used, carefully drill the opening. (The plastic is too strong to be punched out.)

- Secure the Magmeter in a vise to prevent damage or injury.
- The plastic inside the port is very thin. Do not allow the drill to penetrate too deeply and damage the Magmeter wiring.

Important:

- The directional arrow on the sensor body **MUST** be pointed **DOWNSTREAM** for correct operation. (Digital (S³L) and 4 to 20 mA will not work if flow is against direction of arrow).
- The **FLOW** arrow decal can be placed directly on the pipe to identify the direction of flow.
- Use a cable gland or a liquid tight connector to seal the cable ports from water intrusion.
- The yellow housing may be reversed to align the conduit ports as required.
- If the Magmeter is installed on a vertical pipe, the conduit ports should be turned to point downward. This will prevent condensation from being channeled into the enclosure.
- Use plumber's tape or a suitable sealant on cable ports.

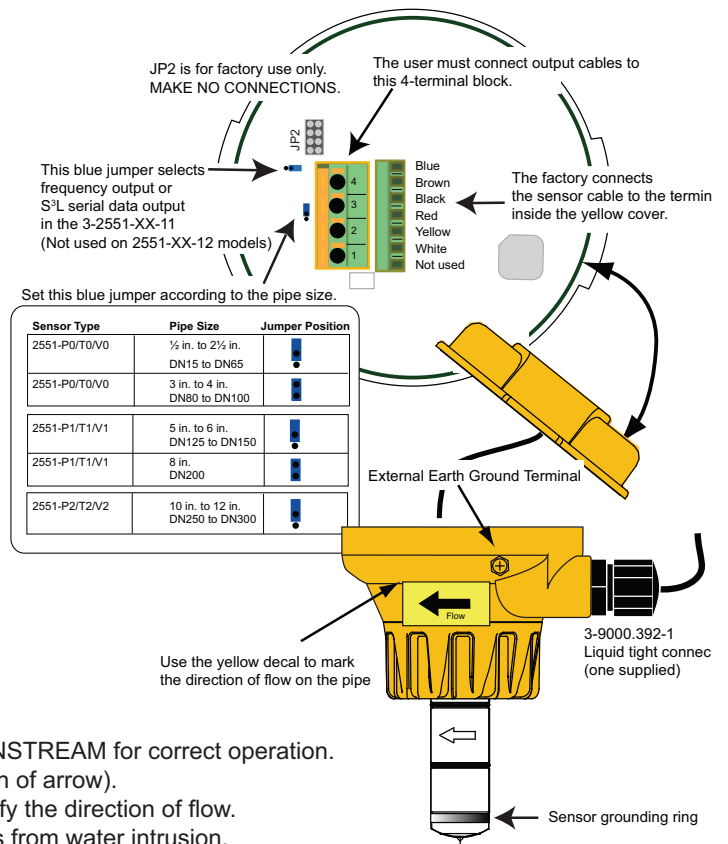

WARNING!

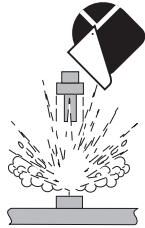

FAILURE TO FOLLOW THESE INSTRUCTIONS MAY RESULT IN THE SENSOR BEING EJECTED FROM THE PIPE!

- **DO NOT USE ANY TOOLS ON THE RETAINING CAP. HAND TIGHTEN ONLY.**
- **LUBRICATE O-RINGS WITH A NON-PETROLEUM BASED, VISCOUS LUBRICANT (GREASE) COMPATIBLE WITH THE SYSTEM.**
- **DO NOT USE THREAD SEALANT OR LUBRICANTS ON THE RETAINING CAP OR ON THE PLASTIC FITTING THREADS.**
- **IF LEAKING IS OBSERVED FROM THE RETAINING CAP, IT INDICATES DEFECTIVE OR WORN O-RINGS ON THE SENSOR. DO NOT ATTEMPT TO CORRECT BY FURTHER TIGHTENING.**

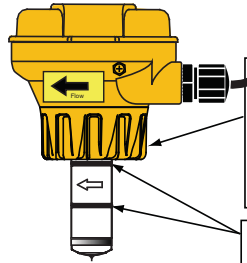

Do not use any tools to tighten the yellow retaining cap. DO NOT USE thread sealant or lubricants on retaining cap!

Lubricate O-rings with a viscous non-petroleum based lubricant (grease) compatible with the system.

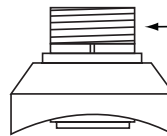

DO NOT USE thread sealant or lubricants on the fitting threads.

CHEMICAL COMPATIBILITY WARNING

The retaining nuts of Magmeters are not designed for prolonged contact with aggressive substances. Strong acids, caustic substances and solvents or their vapor may lead to failure of the retaining nut, ejection of the sensor and loss of the process fluid with possibly serious consequences, such as damage to equipment and serious personal injury. Retaining nuts that may have been in contact with such substances, e.g. due to leakage or spilling, must be replaced.

6. General Installation and Grounding Tips

Sensor conditioning

The Magmeter output signal may be unstable immediately after installation. Allowing the sensor to soak in a full pipe (or in any container of water) for 24 hours will stabilize the performance.

- Very low conductivity fluids may require a longer conditioning period. (The Magmeter will not operate properly in fluids where the conductivity is less than 20 $\mu\text{S}/\text{cm}$.)

Grounding

The 2551 Magmeter is unaffected by moderate levels of electrical noise. However, in some applications it may be necessary to ground portions of the system to eliminate electrical interference. The grounding requirements will vary with each installation.

One or more of the following steps may be applied if the 2551 Magmeter is affected by electrical noise:

- ① The ground terminal on the outside of the yellow housing is connected internally to the grounding ring at the tip of the sensor. Connect a wire (14 AWG/2.08 mm^2 recommended) from this terminal directly to a local Earth ground.
- ② Install fluid grounding devices immediately upstream and downstream of the Magmeter. Connect the fluid grounds to the Earth ground terminal on the 2551. Use flanged grounding rings or metal electrodes on plastic pipes, or metal clamps on metal pipes. Fluid grounds must be in direct contact with the fluid, and as near to the Magmeter as possible.
- ③ The shield from the output cable must be terminated at the remote instrument ONLY. This shield must be connected at only one end!
- ④ Connect an additional wire (minimum AWG 14/2.08 mm^2) from the remote instrument ground to the Magmeter ground terminal.

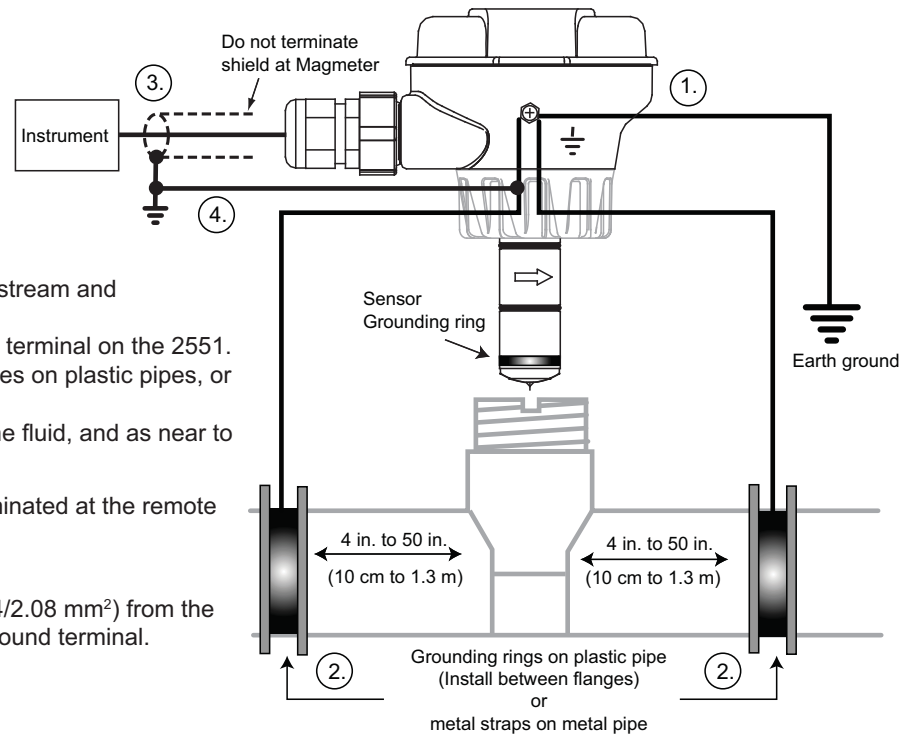

7. Wiring the 2551-XX-12 Magmeter with 4 to 20 mA Loop Output

The 2551-XX-12 Magmeter is a traditional 2-wire passive 4 to 20 mA loop transmitter.

- External loop power (24 VDC \pm 10%) is required. See Ordering Information for power supplies.
- **The maximum loop resistance the Magmeter can accommodate is 300 Ω .**
- All 2551-XX-12 Magmeters are shipped from the factory with the 4 to 20 mA output scaled for 0 to 5 m/s (0 to 16.4 ft/s). If this operating range is suitable, no adjustments are necessary.
- The Calibration Tables on pages 7-10 list the 20 mA setpoint for each installation fitting. Use this information to program the 4 to 20 mA range of the loop device (PLC, Datalogger, recorder, etc.)
- The 3-0250 USB to Digital (S³L) Configuration/Diagnostic Tool is required to change the operating range.

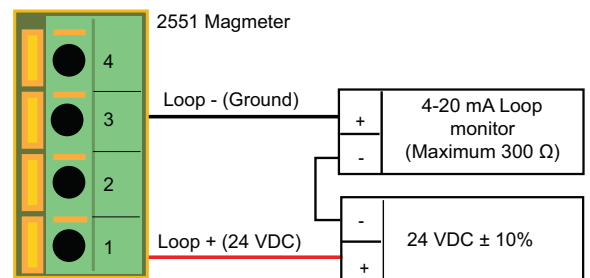

8. Wiring the 3-2551-11 with Frequency or Digital (S³L) output

8.1 Wiring: Frequency output (Compatible with all POWERED Signet Flow instruments.)

- When the blue jumper illustrated here is placed over both pins, the 2551-XX-11 outputs an open collector frequency signal that can be connected to any powered Signet flow meter (models 5600, 8900, 9900).
- 5 VDC power is provided to the 2551 Magmeter by all Signet flow instruments. No additional power is required.
- The frequency output will be displayed as positive flow regardless of the flow direction.**

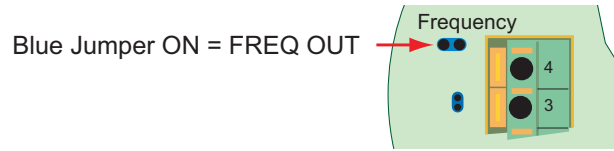

2551 Wiring to Signet 8900 and 9900

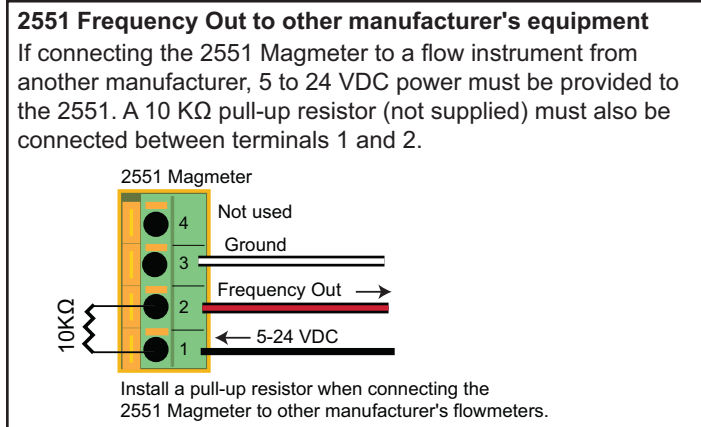
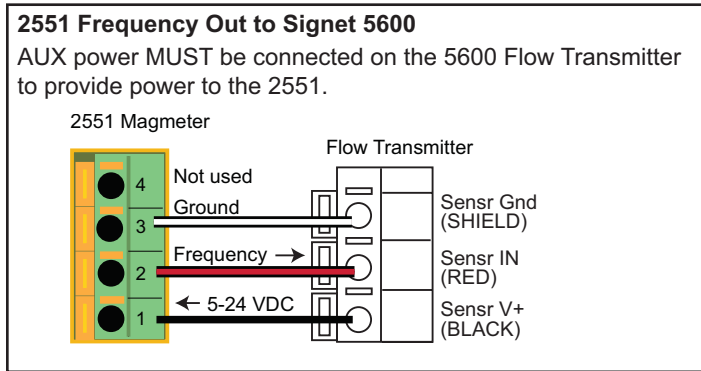
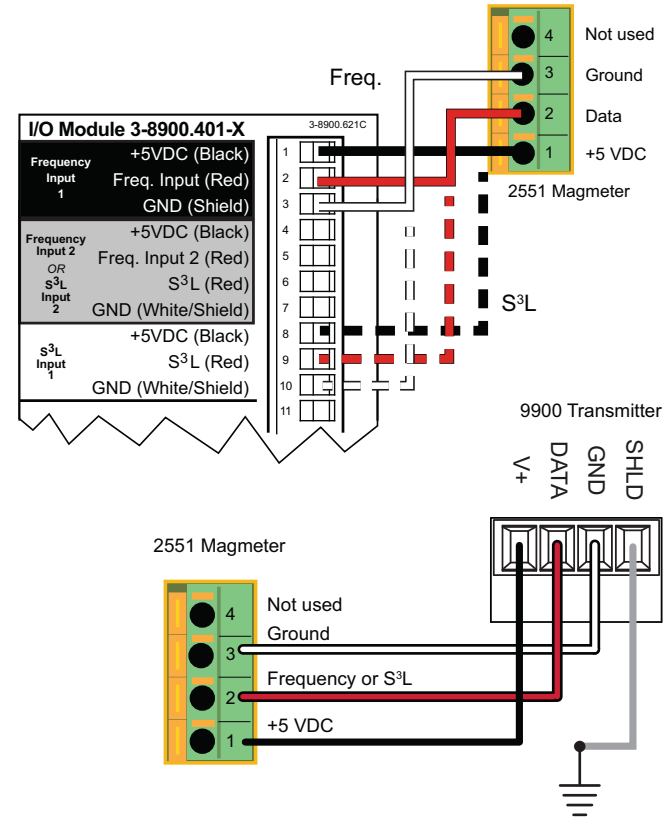

8.2 Wiring: S³L output (Compatible with 8900 Multi-Parameter Controller and 9900 Transmitter only)

- When the blue jumper illustrated here is removed (or placed over one pin for storage) the 2551-XX-11 outputs a Digital (S³L) signal compatible with the Signet 8900 and 9900.
- The 2551 receives 5 VDC power from the 8900 or 9900. No additional power is required.
- The 8900 will display 0 (Zero) flow rate during periods of reverse flow. The 9900 will display negative numbers to indicate reverse flow.**
- The maximum cable length from the 2551 to the 8900 or 9900 depends on the 8900 or 9900 configuration. Refer to the 8900 or 9900 manual for complete information.

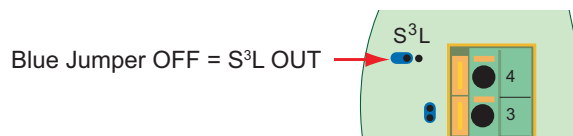

9. Calibration and Software Configuration

No calibration is necessary to begin using the 2551. The application and performance settings are pre-set to meet the requirements of most applications.

The 2551 application and performance settings can be customized using the Signet 3-0250 USB to Digital (S³L) Configuration/Diagnostic Tool and software. Refer to the Signet 3-0250 USB-to-S³L Configuration/Diagnostic Tool manual for details to adjust the following parameters:

- 4 to 20 mA span:** Factory setting is 0 to 5 m/s. Can be customized to any range.
- Noise Rejection Filter:** Factory set for 60 Hz. Can be changed to 50 Hz.
- Low Flow Cutoff:** Factory setting is 0.05 m/s. Can be customized to any velocity.
- Averaging Time:** Factory setting is 14 seconds. Can be customized from 0.1 seconds to 100 seconds.
- Sensitivity:** Factory setting is 25% of full scale. Can be customized to any % of full scale.

10. Calibration Data: K-factors and Full Scale Current Values

Plastic Installation Fittings: PVC Tees and Saddles

Pipe Size (In.)	Fitting Type	K-Factor Gallons	K-Factor Liters	20 mA= in GPM	20 mA= in LPM
SCH 80 PVC-U TEES FOR SCH 80 PVC PIPE					
½	MPV8T005	2277.0	601.58	13.1	49.6
¾	MPV8T007	1407.6	371.90	20.97	79.38
1	MPV8T010	861.17	227.52	34.21	129.5
1¼	MPV8T012	464.91	122.83	67.1	253.99
1½	MPV8T015	331.43	87.56	92.54	350.25
2	MPV8T020	192.89	50.96	145.15	549.38

SCH 80 PVC TEES FOR SCH 80 PVC PIPE

2½	PV8T025	131.46	34.73	228.2	863.74
3	PV8T030	82.52	21.80	363.55	1376.04
4	PV8T040	44.78	11.83	669.88	2535.49

SCH 80 PVC TEES FOR SCH 80 CPVC PIPE

½	MCPV8T005	2277.0	601.58	13.18	49.87
¾	MCPV8T007	1407.6	371.90	21.31	80.67
1	MCPV8T010	861.17	227.52	34.84	131.86
1¼	MCPV8T012	464.91	122.83	64.53	244.24
1½	MCPV8T015	331.43	87.56	90.52	342.62
2	MCPV8T020	192.89	50.96	155.53	588.70

SCH 80 PVC SADDLES FOR SCH 80 PVC PIPE

2	PV8S020	193.83	51.21	154.77	585.81
2½	PV8S025	138.01	36.46	217.38	822.78
3	PV8S030	83.89	22.16	357.62	1353.60
4	PV8S040	40.88	10.80	733.88	2777.74
6	PV8S060	22.53	5.95	1331.85	5041.06
8	PV8S080	12.52	3.31	2395.41	9066.64
10	PV8S100	7.94	2.10	3778.75	14302.57
12	PV8S120	5.71	1.51	5256.69	19896.57

SCH 80 PVC SADDLES FOR SCH 40 PVC PIPE

2	PV8S020	180.01	47.56	166.66	630.81
2½	PV8S025	123.72	32.69	242.49	917.82
3	PV8S030	75.81	20.03	395.71	1497.76
4	PV8S040	41.87	11.06	716.56	2712.19
6	PV8S060	19.71	5.21	1521.92	5760.46
8	PV8S080	11.73	3.10	2558.12	9682.50
10	PV8S100	7.43	1.96	4037.60	15282.3
12	PV8S120	5.23	1.38	5734.87	21706.48

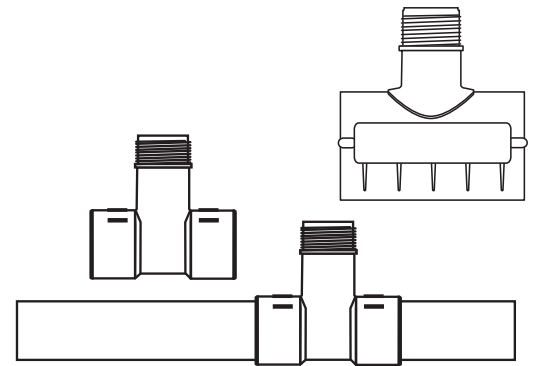

10. Calibration Data: K-factors and Full Scale Current Values

Plastic Installation Fittings for Metric Pipes:

Polypropylene True Union Tees and Wafers

PVDF True Union Tees

PVC True Union Tees

Pipe Size (Metric)	Fitting Type	K-Factor Gallons	K-Factor Liters	20 mA= in GPM	20 mA= in LPM
POLYPROPYLENE FITTINGS (DIN/ISO, BS, ANSI)					
DN15	PPMT005	2192.73	579.32	13.68	51.78
DN20	PPMT007	1327.81	350.81	22.59	85.52
DN25	PPMT010	737.16	194.76	40.70	154.04
DN32	PPMT012	453.46	119.81	66.16	250.41
DN40	PPMT015	275.03	72.66	109.08	412.86
DN50	PPMT020	164.17	43.35	182.74	691.66
PVDF FITTINGS (DIN/ISO, BS, ANSI)					
DN15	SFMT005	1946.49	514.26	15.41	58.34
DN20	SFMT007	1158.05	305.96	25.91	98.05
DN25	SFMT010	749.09	197.91	40.05	151.58
DN32	SFMT012	439.51	116.12	68.26	258.36
DN40	SFMT015	248.93	65.77	120.52	456.16
DN50	SFMT020	146.85	38.80	204.30	773.26
PVC FITTINGS (DIN/ISO, BS, ANSI)					
DN15	PVMT005	2067.76	546.30	14.51	54.91
DN20	PVMT007	1136.61	300.29	26.39	99.90
DN25	PVMT010	716.52	189.31	41.87	158.47
DN32	PVMT012	446.07	117.85	67.25	254.56
DN40	PVMT015	278.83	73.67	107.59	407.23
DN50	PVMT020	159.36	42.10	188.26	712.55

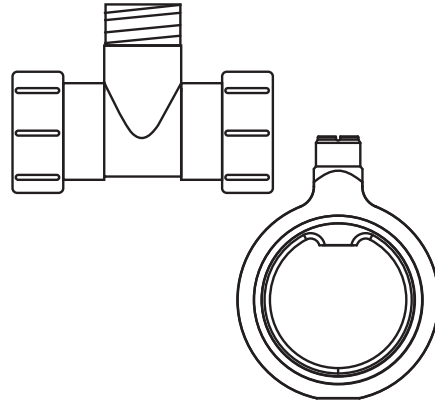

10. Calibration Data: K-factors and Full Scale Current Values

Metal Installation Fittings:

Carbon Steel Tees and Weld-o-Lets

Stainless Steel Tees and Weld-o-Lets

Galvanized Iron Tees

Pipe Size (In.)	Fitting Type	K-Factor Gallons	K-Factor Liters	20 mA= in GPM	20 mA= in LPM
CARBON STEEL TEES ON SCH 40 PIPE					
½	CS4T005	1572.66	415.50	19.08	72.20
¾	CS4T007	1086.73	287.11	27.61	104.49
1	CS4T010	582.34	153.86	51.52	194.99
1¼	CS4T012	377.48	99.73	79.48	300.81
1½	CS4T015	267.79	70.75	112.03	424.02
2	CS4T020	167.85	44.35	178.73	676.48

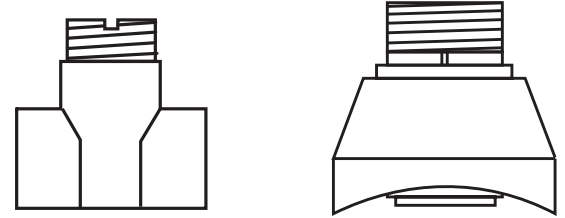

STAINLESS STEEL TEES ON SCH 40 PIPE

½	CR4T005	1601.26	423.05	18.74	70.91
¾	CR4T007	937.78	247.76	31.99	121.08
1	CR4T010	606.18	160.15	49.49	187.32
1¼	CR4T012	279.68	73.89	107.26	405.99
1½	CR4T015	147.65	39.01	203.19	769.06
2	CR4T020	111.90	29.56	268.09	1014.73

STAINLESS STEEL WELDOLETS ON SCH 40 PIPE

2½	CR4W025	106.31	28.09	282.19	1068.10
3	CR4W030	72.27	19.09	415.12	1571.25
4	CR4W040	36.84	9.73	814.34	3082.28
5	CR4W050	29.28	7.73	1024.70	3878.50
6	CR4W060	20.29	5.36	1478.26	5595.21
8	CR4W080	11.73	3.10	2557.72	9680.96
10	CR4W100	7.45	1.97	4028.83	15249.13
12	CR4W120	5.24	1.39	5722.73	21660.53

CARBON STEEL WELDOLETS ON SCH 40 PIPE

2½	CS4W025	105.70	27.93	283.82	1074.27
3	CS4W030	70.68	18.67	424.45	1606.56
4	CS4W040	36.38	9.61	824.65	3121.30
5	CS4W050	29.28	7.73	1024.70	3878.50
6	CS4W060	20.29	5.36	1478.26	5595.21
8	CS4W080	11.73	3.10	2557.72	9680.96
10	CS4W100	7.45	1.97	4028.83	15249.13
12	CS4W120	5.24	1.39	5722.73	21660.53

GALVANIZED IRON TEES ON SCH 40 PIPE

1	IR4T010	558.50	147.56	53.71	203.31
1¼	IR4T012	334.45	88.36	89.70	339.51
1½	IR4T015	248.97	65.78	120.49	456.07
2	IR4T020	146.00	38.57	205.48	777.76

10. Calibration Data: K-Factors and Full Scale Current Values

Metal Installation Fittings

Iron Saddles

Pipe Size (In.)	Fitting Type	K-Factor Gallons	K-Factor Liters	20 mA= in GPM	20 mA= in LPM
SCH 80 IRON SADDLE ON SCH 80 PIPE					
2	IR8S020	194.85	51.48	153.96	582.75
2½	IR8S025	142.28	37.59	210.86	798.10
3	IR8S030	87.53	23.13	342.72	1297.20
4	IR8S040	40.62	10.73	738.58	2795.54
5	IR8S050	29.28	7.74	1024.43	3877.48
6	IR8S060	22.30	5.89	1345.58	5093.03
8	IR8S080	12.52	3.31	2395.41	9066.64
10	IR8S100	7.94	2.10	3778.75	14302.57
12	IR8S120	5.65	1.49	5311.45	20103.83
SCH 80 IRON SADDLE ON SCH 40 PIPE					
2	IR8S020	185.35	48.97	161.85	612.61
2½	IR8S025	127.47	33.68	235.36	890.83
3	IR8S030	76.62	20.24	391.54	1481.99
4	IR8S040	40.23	10.63	745.72	2822.57
5	IR8S050	27.32	7.22	1098.24	4156.83
6	IR8S060	19.71	5.21	1521.92	5760.46
8	IR8S080	11.61	3.07	2584.23	9781.30
10	IR8S100	7.36	1.94	4078.8	15438.2
12	IR8S120	5.18	1.37	5793.39	21927.98

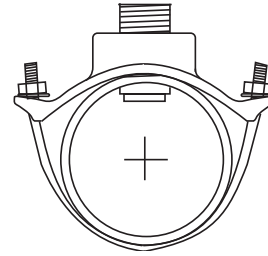

Metal Installation Fittings:

Bronze and Copper Tees and Brazolets

Pipe Size (In.)	Fitting Type	K-Factor Gallons	K-Factor Liters	20 mA= in GPM	20 mA= in LPM
BRONZE TEES ON SCH 40 PIPE					
1	BR4T010	582.34	153.86	51.52	194.99
1¼	BR4T012	330.54	87.33	90.76	343.53
1½	BR4T015	254.76	67.31	117.76	445.71
2	BR4T020	157.36	41.58	190.64	721.58
COPPER TEES FITTING ON COPPER PIPE SCH K					
½	CUKT005	2459.19	649.72	12.20	46.17
¾	CUKT007	1108.02	292.74	27.08	102.48
1	CUKT010	649.87	171.70	46.16	174.73
1¼	CUKT012	422.03	111.50	71.09	269.06
1½	CUKT015	281.43	74.35	106.60	403.47
2	CUKT020	136.02	35.94	220.55	834.78
COPPER TEES FITTING ON COPPER PIPE SCH L					
½	CUKT005	2406.30	635.75	12.47	47.19
¾	CUKT007	1174.77	310.37	25.54	96.66
1	CUKT010	672.28	177.62	44.62	168.90
1¼	CUKT012	402.84	106.43	74.47	281.87
1½	CUKT015	294.99	77.94	101.70	384.92
2	CUKT020	149.63	39.53	200.50	758.89
COPPER/BRONZE BRAZOLET ON SCH 40 PIPE					
2½	BR4B025	117.31	30.99	255.74	967.96
3	BR4B030	78.62	20.77	381.58	1444.28
4	BR4B040	45.13	11.92	664.77	2516.15
5	BR4B050	32.79	8.66	914.91	3462.95
6	BR4B060	22.73	6.01	1319.87	4995.72
8	BR4B080	13.14	3.47	2283.68	8643.71
10	BR4B100	8.34	2.20	3597.17	13615.29
12	BR4B120	5.87	1.55	5109.58	19339.76

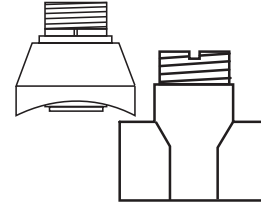

11. Maintenance

The 2551 Magmeter requires very little maintenance. There are no user-serviceable components in the Magmeter.

- If the fluid contains deposits and solids that may coat the electrodes, a regular cleaning schedule is recommended.
- Do not use abrasive materials on the metal electrodes. Clean with soft cloth and mild detergent only.
- Use a cotton swab and mild detergent to remove deposits on the metal electrodes at the tip of the sensor.

11.1 Environmental Recommendations:

- When used properly, this product presents no inherent danger to the environment.
- Please follow local ordinances when disposing of this or any product with electronic components.

11.2 Troubleshooting

Symptom	Possible Cause	Solution
Output is erratic and unstable.	Magmeter installed too close to upstream obstruction.	Relocate the magmeter to have straight uninterrupted pipe upstream of the sensor for at least 10 x the pipe diameter.
	Magmeter located in area exposed to air bubbles/pockets.	Eliminate air bubbles in the pipe.
	Magmeter is installed in pipe backwards.	Remove the magmeter and reinstall with the flow direction arrow on the sensor body pointed DOWNSTREAM .
	Electrical noise is interfering with the measurement.	Review the grounding of the magmeter and the pipe. Install adequate Earth ground to allow the Magmeter to operate properly.
	Electrodes are coated with solids.	Carefully clean the electrodes. Refer to sensor manual for details.
	New sensor; metal surface not properly conditioned.	Soak sensor overnight in fluid.
Output is not 0 when flow is stopped.	Electrodes not adequately conditioned.	Soak sensor overnight in fluid.
	Vibration or other movement in pipe causes magmeter to detect flow.	Increase the Low Flow Cutoff.
	Electrical noise interference.	Modify grounding to protect the Magmeter from interference.
	Defective Magmeter.	Return to factory for service.
4-20 mA current output is incorrect.	Loop device not scaled same as Magmeter.	Use 3-0250 Setup tool to respan the Magmeter to match Loop device. Respan Loop device to match Magmeter.
	Range Jumper not placed correctly.	Set Range Jumper correctly.
	Defective Magmeter.	Return to factory for service
	2551 is wrong model.	Frequency/S ³ L model: 3-2551-11
Frequency output is inoperative Digital (S ³ L) output is inoperative. Loop output is inoperative.	Blue jumper not in correct position.	Place blue jumper correctly. (Sec. 5 pg. 4)
	Wiring is not correct.	Check wiring, make corrections.
	Frequency input to other manufacturer's flow instrument does not have pull-up resistor.	Install 10 kΩ resistor. (section 8.1, pg. 6)
Output is 22.1 mA	Conductivity is less than 20 μS/cm (the fluid is too clean for Magmeter).	Unsuitable application for Magmeter.
	Electronic component failure.	Return 2551 to factory.

11.3 Troubleshooting with the RED and BLUE LEDs

Both Off:	The power is off or the sensor is not connected.
Solid Blue:	The power is on, the pipe is full, but there is no flow in the pipe.
Blinking Blue:	Normal operation, blink rate is proportional to the flow rate.
Alternating Red-Blue:	Empty pipe indication (electrodes are not wet).
Blinking Red:	System errors (electrical noise interference).
Solid Red:	Instrument error (defective electronics component).

If the 2551 detects an empty pipe:

- Frequency output will be locked to 0 Hz if electrodes are not wet.
- Digital (S³L) output will be locked to 0 if electrodes are not wet.
- 4 to 20 mA will be locked to 4 mA if electrodes are not wet.
- Blue and red LEDs will blink alternately if electrodes are not wet.

If the 2551 detects REVERSE FLOW:

- Frequency out cannot distinguish reverse flow from forward flow. The output will be the absolute value.
- With Digital (S³L) output, reverse flow results in 0 flow rate displayed on 8900 or with negative numbers on the 9900.
- 4-20 mA output can be spanned into negative flow range using the 3-0250 USB Setup Tool and software. (See section 9) (example: 4-20 mA = -100 to +100 GPM).

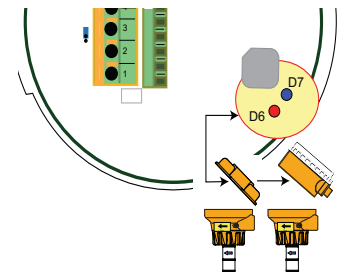

12. Ordering Information

Sensor Part No.	
3-2551	
Sensor Body (Transducer) and electrodes/grounding ring materials - Choose one	
-P	Polypropylene and 316L SS
-T	PVDF and Titanium
-V	PVDF and Hastelloy C
Pipe size - Choose one	
0	DN15 to DN100 (½ to 4 in.)
1	DN125 to DN200 (5 to 8 in.)
2	DN250 to DN900 (10 to 36 in.)
Display Options - Choose One	
-1	No Display
Output options - Choose One	
1	Frequency, Digital (S ³ L)
2	4 to 20 mA output
3-2551	-P 0 -1 2 Example Part Number

Part Number	Code	Part Number	Code
3-2551-P0-11	159 001 105	3-2551-T2-11	159 001 448
3-2551-P0-12	159 001 110	3-2551-T2-12	159 001 449
3-2551-P1-11	159 001 106	3-2551-V0-11	159 001 257
3-2551-P1-12	159 001 111	3-2551-V0-12	159 001 259
3-2551-P2-11	159 001 107	3-2551-V1-11	159 001 258
3-2551-P2-12	159 001 112	3-2551-V1-12	159 001 260
3-2551-T0-11	159 001 108	3-2551-V2-11	159 001 450
3-2551-T0-12	159 001 113	3-2551-V2-12	159 001 451
3-2551-T1-11	159 001 109		
3-2551-T1-12	159 001 114		

Replacement Parts and Accessories

Mfr. Part No.	Code	Description
1220-0021	198 801 186	O-ring, FPM
1224-0021	198 820 006	O-ring, EPDM
1228-0021	198 820 007	O-ring, FFPM
3-2551-11	159 001 215	Magmeter electronics, no display, frequency or Digital (S ³ L) output
3-2551-12	159 001 216	Magmeter electronics, no display, 4 to 20 mA output
3-2551-P0	159 001 211	PP/316L SS, DN15 to DN100 (½ to 4 in.) pipe
3-2551-P1	159 001 212	PP/316L SS, DN125 to DN200 (5 to 8 in.) pipe
3-2551-P2	159 001 444	PP/316L SS, DN250 to DN900 (10 to 36 in.) pipe
3-2551-T0	159 001 213	PVDF/Titanium, DN15 to DN100 (½ to 4 in.) pipe
3-2551-T1	159 001 214	PVDF/Titanium, DN125 to DN200 (5 to 8 in.) pipe
3-2551-T2	159 000 445	PVDF/Titanium, DN250 to DN900 (10 to 36 in.) pipe
3-2551-V0	159 001 376	PVDF/Hastelloy-C, DN15 to DN100 (½ to 4 in.) pipe
3-2551-V1	159 001 377	PVDF/Hastelloy-C, DN125 to DN200 (5 to 8 in.) pipe
3-2551-V2	159 000 446	PVDF/Hastelloy-C, DN250 to DN900 (10 to 36 in.) pipe
7300-7524	159 000 687	24 VDC Power Supply 7.5 W, 300 mA
7300-1524	159 000 688	24 VDC Power Supply 15 W, 600 mA
7300-3024	159 000 689	24 VDC Power Supply 30 W, 1.3 A
7300-5024	159 000 690	24 VDC Power Supply 50 W, 2.1 A
7300-1024	159 000 691	24 VDC Power Supply 100 W, 4.2 A
3-0250	159 001 538	USB to Digital (S ³ L) Configuration/Diagnostic Tool
3-8050.390-1	159 001 702	Retaining Nut Replacement Kit, NPT, Valox®
3-8050.390-3	159 310 116	Retaining Nut Replacement Kit, NPT, PP
3-8050.390-4	159 310 117	Retaining Nut Replacement Kit, NPT, PVDF
3-8050.391	159 001 703	Retaining Nut Replacement Kit, NPT, Stainless Steel
3-9000.392-1	159 000 839	Liquid-tight connector kit, 1 set, ½ in. NPT



Georg Fischer Signet LLC, 3401 Aero Jet Avenue, El Monte, CA 91731-2882 U.S.A. • Tel. (626) 571-2770 • Fax (626) 573-2057
 For Worldwide Sales and Service, visit our website: www.gfsignet.com • Or call (in the U.S.): (800) 854-4090
 For the most up-to-date information, please refer to our website at www.gfsignet.com